

EXA100

Manual Generated: 19/11/2024 - 12:33

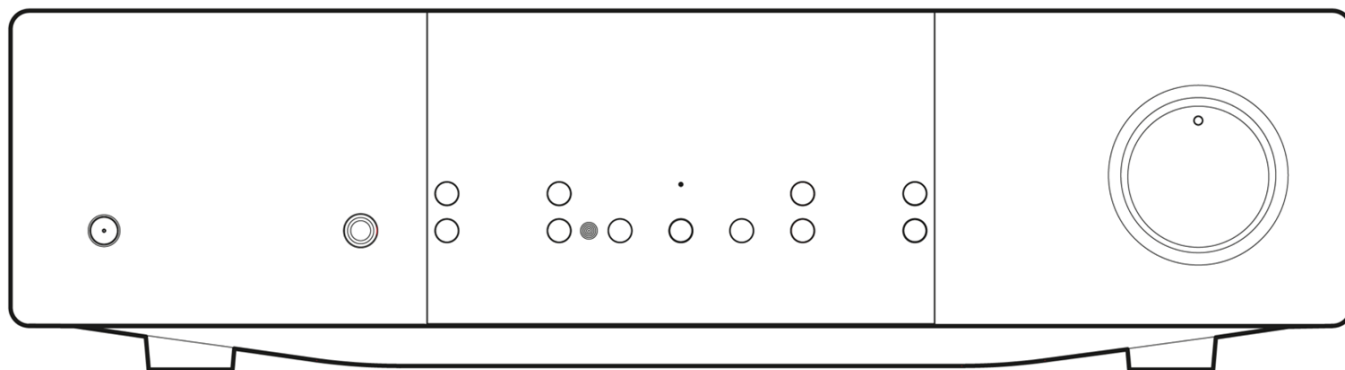

Table of Contents

EXA100	3
Introduction	3
What's included with the EXA100?	4
Front panel controls	5
Rear panel connections	6
Remote control	9
Getting connected	10
USB Audio Connection	14
Setup menu	17
Bluetooth	19
Control Bus	20
CAP Protection	22
Troubleshooting	23
Technical specifications	24
Frequently Asked Questions (FAQ)	25

EXA100

Last updated: November 19, 2024 10:20. Revision #14157



Introduction

Last updated: October 2, 2024 01:54. Revision #14122

This guide is designed to make installing and using this product as easy as possible. Information in this document has been carefully checked for accuracy at the time of printing; however, Cambridge Audio's policy is one of continuous improvement, therefore design and specifications are subject to change without prior notice.

This document contains proprietary information protected by copyright. All rights are reserved. No part of this manual may be reproduced by any mechanical, electronic or other means, in any form, without prior written permission of the manufacturer. All trademarks and registered trademarks are the property of their respective owners.

The Bluetooth® word mark and logos are registered trademarks owned by the Bluetooth SIG, Inc. and any use of such marks by Audio Partnership Plc is under license. Other trademarks and trade names are those of their respective owners.

Qualcomm is a trademark of Qualcomm Incorporated, registered in the United States and other countries, used with permission. aptX is a trademark of Qualcomm Technologies International, Ltd., registered in the United States and other countries, used with permission.

Qualcomm aptX is a product of Qualcomm Technologies International, Ltd

© Copyright Cambridge Audio Ltd

For upcoming news on future products, software updates and exclusive offers, make sure you register your product at <https://www.cambridgeaudio.com/register>

What's included with the EXA100?

Last updated: October 2, 2024 01:55. Revision #14121

Inside the box of your EXA you will receive:

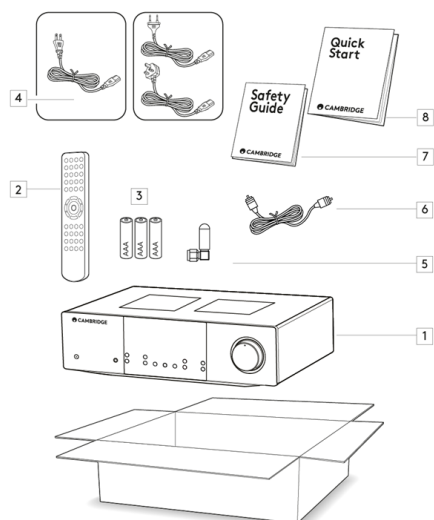

1. EXA100 Integrated Amplifier
2. Remote Control
3. 3 x AAA Batteries
4. Regional power cord
5. Bluetooth Antenna
6. Orange Control Bus Cable
7. Safety Guide
8. Quick start Guide

Front panel controls

Last updated: September 27, 2024 01:50. Revision #14120

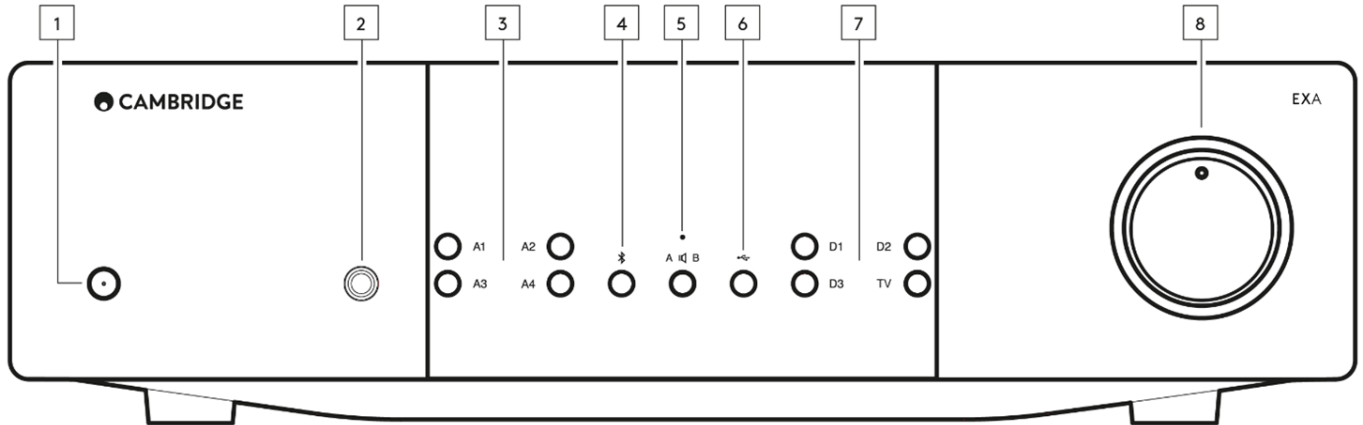

1. **Standby/On** - Switches the unit between Standby mode (indicated by dim power LED) and On (indicated by bright power LED). Standby mode is a low power mode where the power consumption is less than 0.5 Watts.

AUTO POWER DOWN (APD)

The EXA has Auto Power Down (APD) enabled by default, and the unit will automatically switch to standby after 20 minutes of inactivity. See the 'Setup menu' section for further details.

Note: APD is disabled in power amp mode when A1 or A1 balanced are selected, and when a Bluetooth device is connected.

2. **Headphones** - For suitable headphones - connection will automatically mute the loudspeaker and pre-out.
3. **Analogue source select** - Push the appropriate input selection button to select the source you want.
Note: The Balanced and unbalanced input, pressing the A1 input selection button will toggle between balanced and unbalanced. The balanced input is shown by A1 being lit orange, while the unbalanced input is shown by A1 being lit blue. There will be no sound from the amp if the correct input button isn't selected. If an audio source is connected to the balanced input, for example, ensure that the A1 input light is lit orange.
4. **Bluetooth** - Press to turn on the Bluetooth input.
The Bluetooth source allows your player to receive wireless Bluetooth audio from most phones, tablets and laptops.
5. **Speaker A/B** - Press to scroll through the speaker sets connected to the loudspeaker terminals on the back panel (speaker sets A, B or A and B). This can be used for listening to an extra set of loudspeakers in another room. See the 'Connections' section for further details.

Mute indicator

The light will flash to show the outputs are muted by the remote control.

The light will be constantly on indicating that the A1 Power Amp mode on the rear panel of the unit has been turned on.

Protection indicator

See the 'CAP4' section for further details.

6. **USB audio** - Press to select the USB audio input
7. **Digital source select** - Push the appropriate input selection button to select the source that you wish to listen to.
8. **Volume** - Use to increase/decrease the level of the sound from the outputs of the amplifier. This control affects the level of all outputs except when it is in power amp mode A1 and A1 balanced.

Rear panel connections

Last updated: October 2, 2024 02:00. Revision #14119

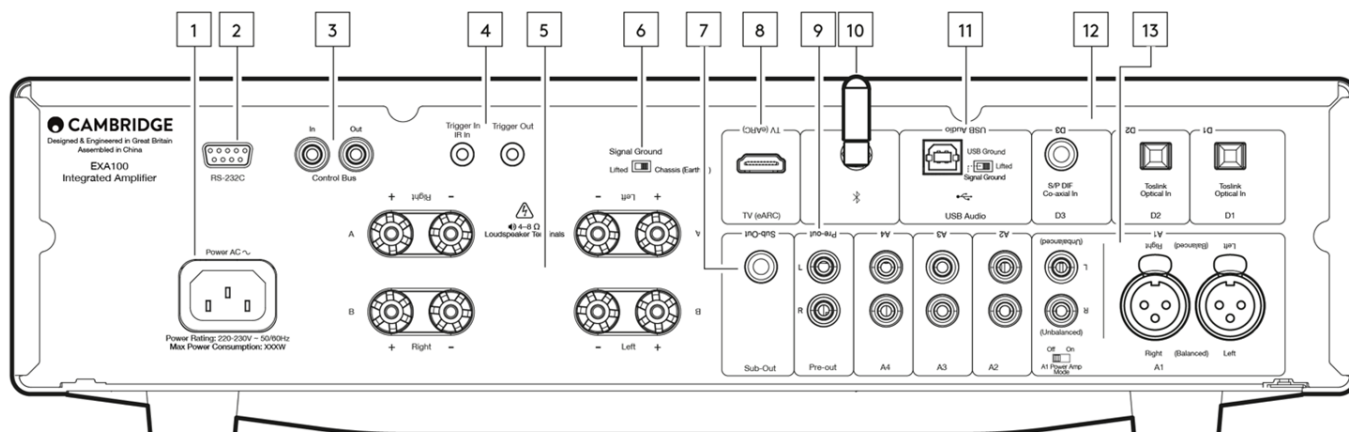

- AC power socket** - Once you have completed all connections to the amplifier, plug the AC power cable into an appropriate mains socket then press standby. Your amplifier is now ready for use.
- RS232C** - RS232 is a standard serial data communication protocol, which allows devices that support RS232 to communicate with each other as part of a home automation system.
Custom install control - a full protocol is available for the EXA on our website [here](#).
- Control Bus** - RCA sockets used to send and receive power and volume commands from other connected EX Series products. For more information on the Control Bus, see 'Control Bus' section.
- Triggers**

Trigger Out - Use a link wire between the EXA and a product that has a trigger input. This will synchronise the power state of both products when powering the EXA on/standby.

Trigger In/IR In

Trigger In - Use a link wire between a product that has a trigger output and the EXA

IR In - Receives modulated IR commands from an IR repeater or custom install systems.

- Speaker terminals**

Note: When using a banana plug, make sure the speaker terminals are completely tightened before inserting the plug.

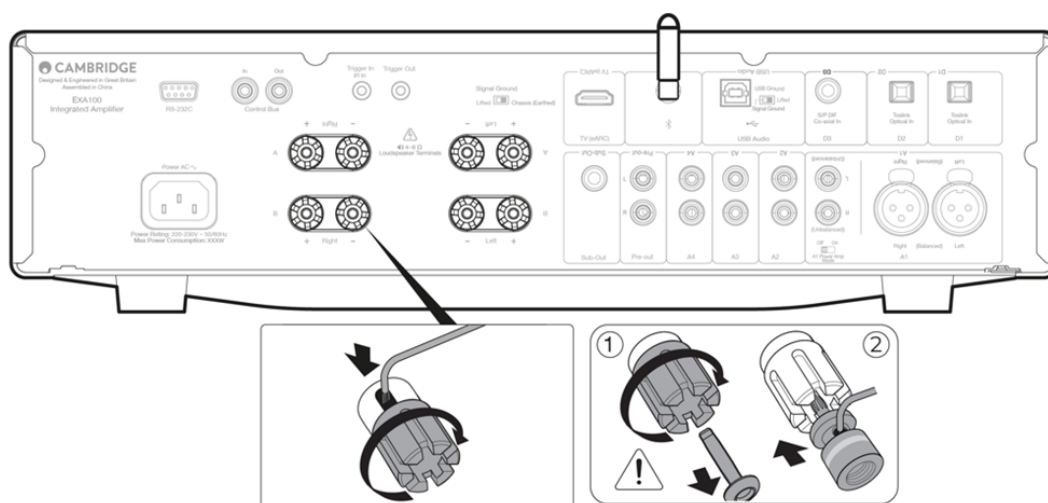

Two sets of loudspeaker terminals are available:

A (main loudspeaker terminals) and **B** (secondary loudspeaker terminals).

Connect the wires from your left channel loudspeaker to the left terminals on the EXA, and the wires from your right channel

loudspeaker to the right terminals on the EXA.

Always ensure that the positive connection on the amplifier is connected to the positive connection on the speaker and the negative connection on the amplifier is connected to the negative connection on the speaker.

The Red terminal is the positive output.

The Black terminal is the negative output.

Care should be taken to ensure no stray strands of wire short the speaker outputs together. Please ensure that the loudspeaker terminals have been tightened completely to provide a good electrical connection.

It is possible for the sound quality to be affected if the screw terminals are loose.

Note: The speaker terminals will need to have the round pips removed before you can insert a banana plug into them.

Tips: The easiest way to remove these is to slightly unscrew the speaker terminal and then do it back up again. This will raise the plug for easy removal.

6. Signal ground

Position **1** - Normal/default position. The main unit audio ground is lifted from chassis earth.

Position **2** - Main unit audio ground is connected directly to chassis ground. For some setups, this can reduce hum or noise when certain TVs, Turntables, and other equipment are connected to the EXN100 unit.

7. Sub out - Connect to the input on an active subwoofer, if required.

Note: There is a low pass filter of approximately 2.3 kHz applied to the Sub Out, no frequencies above 2.3 kHz will be sent to a subwoofer connected to this output. This is so that there is minimal phase added by the EXA at the Sub Out frequencies. The crossover frequency can be adjusted on the Subwoofer itself.

8. Enhanced Audio return channel (eARC) - A connection from a TV that supports both ARC and eARC function.

9. Pre-out - For connection to the unbalanced inputs of a power amplifier or active subwoofer.

Note: There is not a low pass filter applied to the Pre-Out, so the full frequency range will be sent to a subwoofer connected to the Pre-Out.

10. Bluetooth antenna - Used for Bluetooth audio streaming. See 'Bluetooth' section for details.

11. USB audio in - A USB B type socket to enable the playback of audio from a computer running either Microsoft Windows or Apple Mac OS X operating systems. Some builds of Linux are also suitable.

Notes:

- Always use a high-quality USB connection cable certified as USB Hi-Speed. USB cable connections longer than 3m may result in inconsistent audio performance.

- Always turn the volume to minimum, switch to another input or turn the EXA off before plugging/unplugging cables to the USB input or whilst booting up/shutting down your PC/Mac.

Signal Ground/Lift switch - The Signal Ground/Lift switch enables the USB interface earth to connect or disconnect the EXA signal ground. Disconnecting (lifting) the earth can be useful if electronic hum is heard through the speakers when the USB input is selected. The switch should otherwise be left in the Ground position.

12. Digital inputs (D1, D2 AND D3) - TOSLINK and S/P DIF co-axial digital inputs.

Coaxial - Use a high quality 75 ohm digital RCA Phono interconnect cable (not one designed for normal audio use). This input is suitable for 16-24 bit content up to 192kHz.

TOSLINK optical - Use a high quality TOSLINK fibre optic interconnect cable designed specifically for audio use. This input is suitable for 16-24 bit content up to 96kHz (TOSLINK is not recommended at 192kHz sampling rates).

Note: To obtain the best results from your system we recommend using only high-quality Cambridge Audio interconnects. This will ensure that you hear your system as we designed it. Please ask your dealer for details.

13. Analogue inputs (A1 Unbalanced, A2, A3 and A4) - Suitable for any 'line level' source equipment such as CD players, DAB or FM/AM tuners etc.

These inputs are for analogue audio signals only. They should not be connected to the digital output of a CD player or other digital devices.

Note: For the balanced XLR inputs, pin1 is ground, pin2 is positive and pin3 is negative.

A1 inputs

A1 inputs feature either unbalanced (phono/RCA) or balanced (XLR) connections. The balanced connection is the higher quality option and can reject noise and interference in the cable when used with other equipment that supports this function.

An XLR connector is wired Pin 1 - Ground; Pin 2 - Hot (in-phase); Pin 3 - Cold (phase-inverted).

A1 Power Amp Mode:

Off: default position.

On: Activate amplifier mode, this mode is perfectly matched to the external pre-amplifier.



Note: Turn down the volume before enabling power Amp mode.

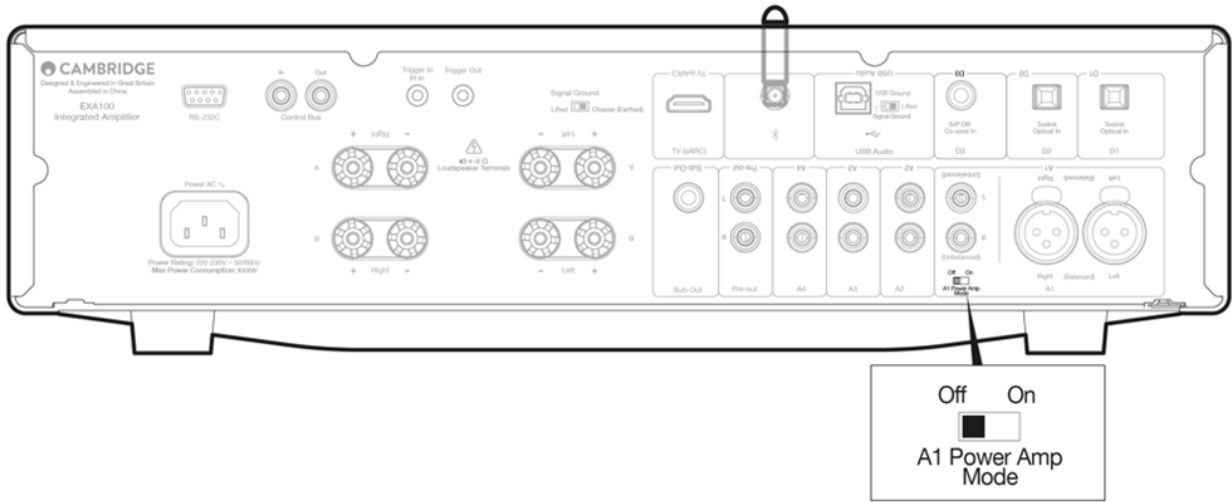

Remote control

Last updated: September 27, 2024 02:17. Revision #14118

The EXA remote control handset duplicates the front panel control functions and is also able to control other EX series products.

Note: The supplied AAA batteries must be fitted before the remote control can be used.

The handset buttons function as described below:

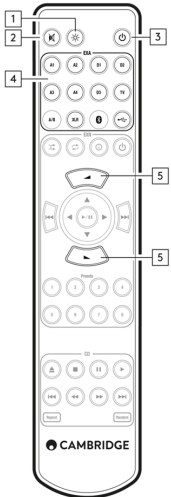

1. **Brightness** - Alters the brightness of the EXA display lights. There are two brightness levels and an option to switch off the backlight. **Note:** When the EXA display lights are selected to be off, selecting any of the functions will briefly switch on the lights to show the change.
2. **Mute** - Press to mute or unmute the loudspeakers, pre-out, sub, and the headphone outputs. The light will flash on the front of the unit to show the outputs are muted.
3. **Standby/On** - Switches the EXA between On and Standby mode.
4. **Sources** - Used to select the source inputs.
Note: the A1 button has the double function of selecting the balanced or unbalanced A1 input and will toggle between the two inputs when double pressing.
5. **Volume up/down** - Volume level adjustment.

Note: If the remote control will not function, please check that the batteries have not expired, and that there is nothing blocking the front panel IR receiver.

Getting connected

Last updated: October 2, 2024 02:14. Revision #14117

When designing our amplifiers, we include features that allow you to connect your system in various ways. The inclusion of features such as Pre-Out and Speaker B connections mean that you can flexibly configure your system depending on your requirements.

Note: When using a banana plug, make sure the speaker terminals are completely tightened before inserting the plug.

Note: The speaker terminals will need to have the round pips removed before you can insert a banana plug into them.

Tips: The easiest way to remove these is to slightly unscrew the speaker terminal and then do it back up again. This will raise the plug for easy removal.

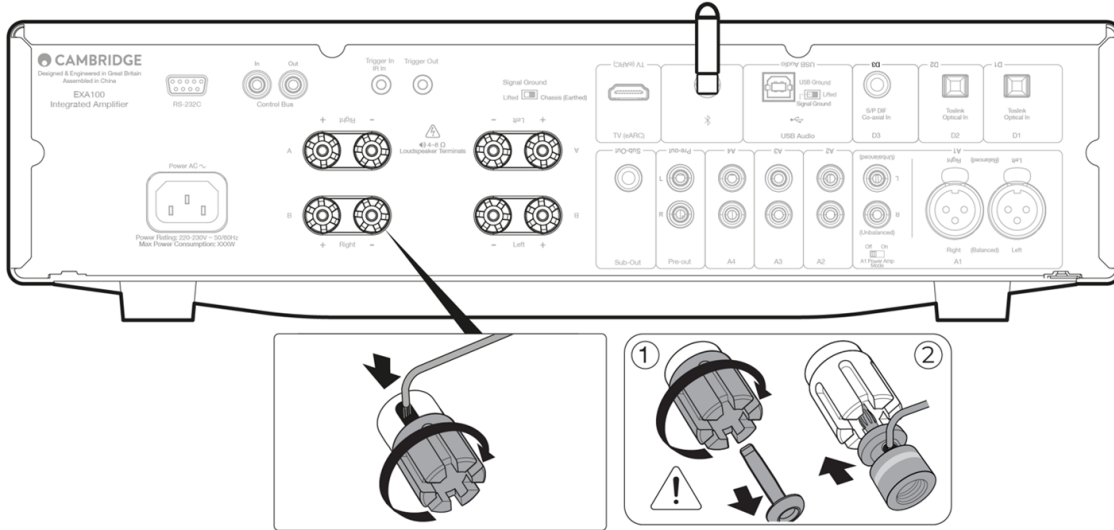

Basic connections

The diagram below shows the basic connection of your amplifier to a CD player using the D3 coaxial digital input source and a pair of loudspeakers.

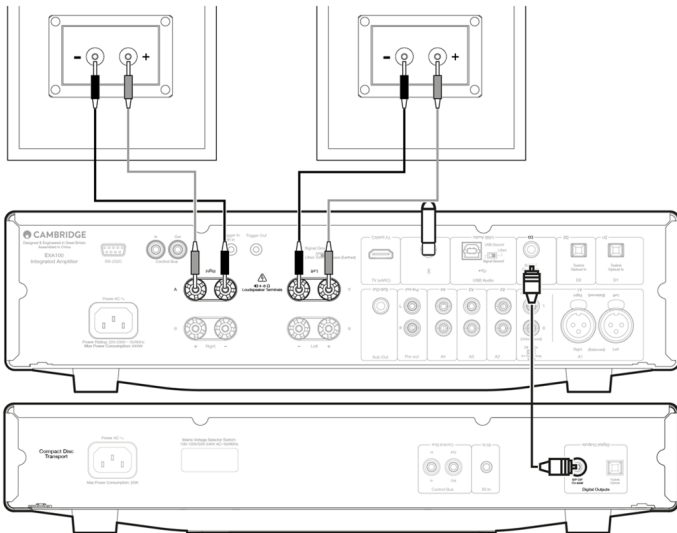

Speaker B connections

The Speaker B connections on the back of the amplifier allow for a second set of speakers to be used (i.e. speakers located in another room). The Speaker A/B button on the front panel scrolls through the selection of speaker A only, speaker B only, and speaker A and B together.

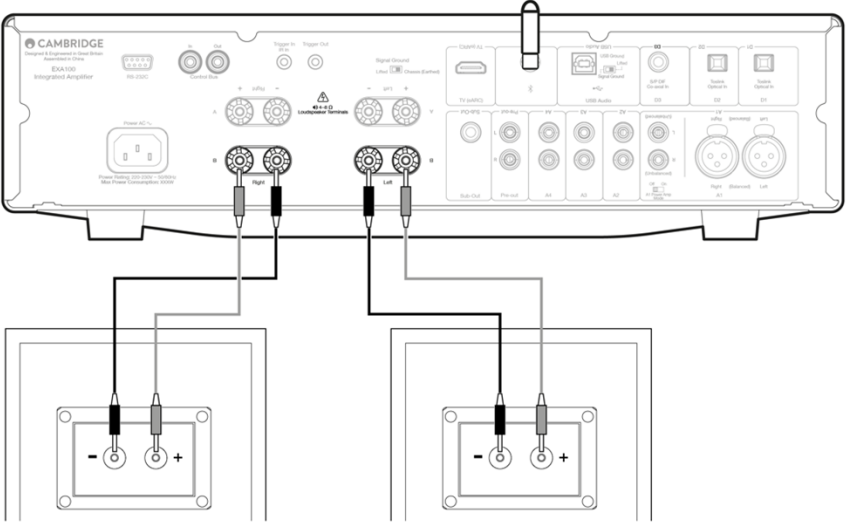

Sub out connections

The Sub Out is for connecting to the LFE/Sub input of an active subwoofer. The diagram below shows how to connect the amplifier to an active subwoofer via the LFE/Sub input on the subwoofer.

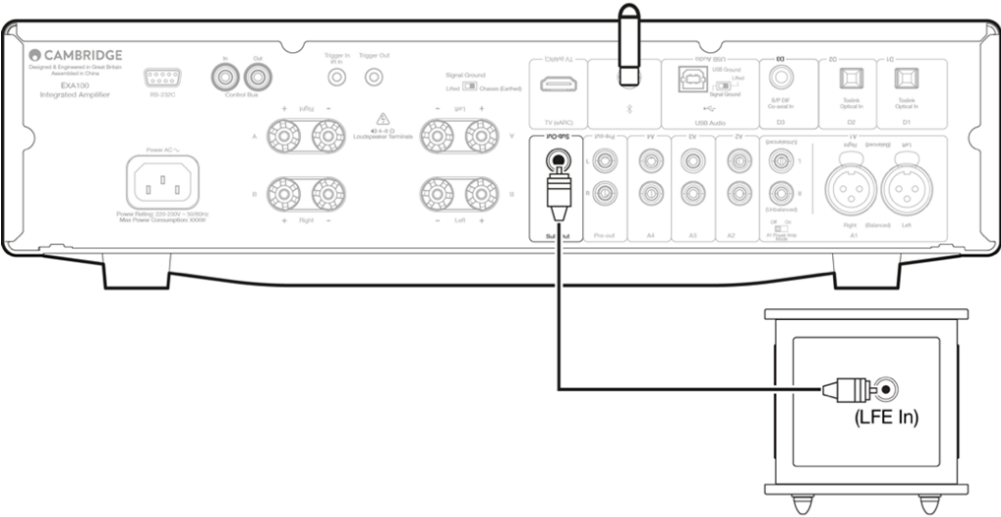

Preamp out connections

The Preamp Out sockets are for connecting to the input sockets of a power amplifier or active subwoofer. The diagram below shows how to connect the amplifier to an active subwoofer via the Line In inputs on the subwoofer.

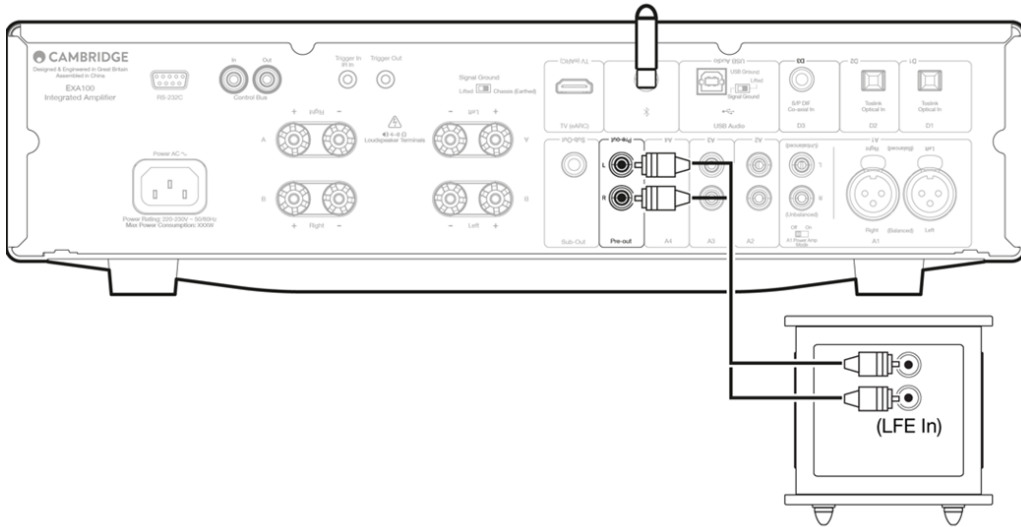

Balanced audio connections

The diagram below shows how to connect the EXA to the EXN Network player using the Balanced Audio inputs via three pin XLR connectors. The EXA can also be connected to non-Cambridge Audio sources with balanced outputs.

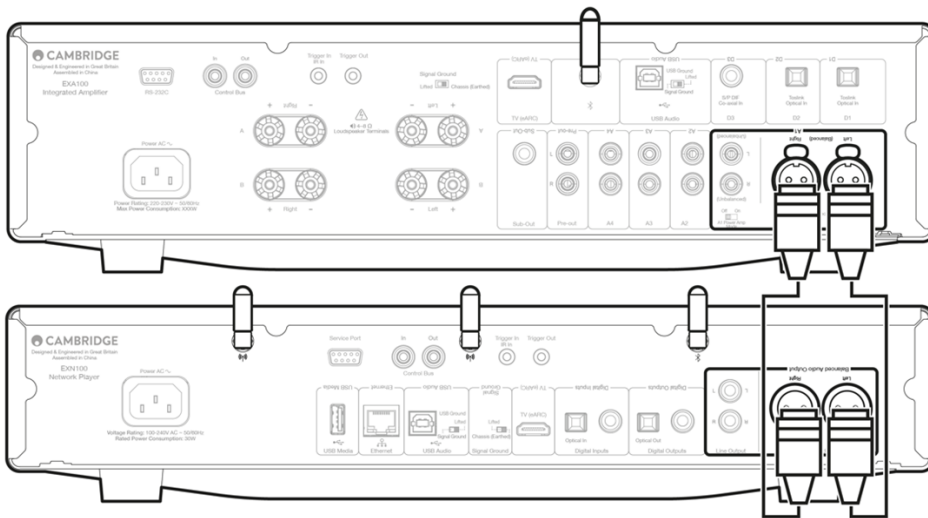

Balanced connections in an audio system are designed to reject electrical noise, from power wiring etc, and also the effects of noise currents flowing through ground connections. The basic principle of balanced interconnection is to get the signal you want by subtraction, using a three-wire connection. One signal wire (the hot or in-phase) carries the normal signal, while other (the cold or phase-inverted) carries an inverted version. The balanced input senses the difference between the two lines to give the wanted signal. Any noise voltages that appear identically on both lines (these are called common-mode signals) are cancelled by the subtraction. The EXA is designed to work at its highest performance when a balanced interconnect is used.

Note: To select the balanced input on the EXA, press the A1 button twice on the front panel or on the remote control so that the A1 light on the front panel display lights up Orange. Repeatedly pressing the A1 button will toggle between balanced and unbalanced inputs.

Connecting a TV

A TV can be connected to one of the digital inputs on the EXA, as long as the TV has the required Optical or Coaxial output. Ensure that the output audio settings on the TV are set to PCM or Stereo, as the EXA is only able to decode a Stereo signal. Please also ensure that the digital input that the TV is connected to has been selected on the front panel of the EXA (D1, D2 or D3).

Enabling 'TV Mode' within the EXA:

Some Connected TVs will send an inconsistent sample rate to the EXA, that the DAC inside the amplifier is unable to process. This can result in audio dropouts and glitches. If this is the case with your EXA, 'TV Mode' will need to be enabled within the amplifier.

To enable 'TV mode' on the EXA:

1. Enter the Setup menu by putting the EXA in standby mode.
2. Whilst in Standby mode, press and hold the Speaker A/B button until the A/B lights flash alternately and the sources A1-A4 light up

See below source buttons for setup configuration:

Note: Button selected (on) is represented by Blue light.

A2 **off** - The EXA is set to the best digital input audio setting on input D2.

A2 **on** - The EXA is set to a more tolerant digital input setting for input D2 that should reduce the chance of having the signal intermittently drop.

3. To save the setup settings and exit the setup menu, press the Speaker A/B button.

Note: Pressing the Standby/On button while in the setup menu will exit this setup menu and will not save the setup settings.

TV Input (ARC/eARC input)

The ARC/eARC function on a TV allows it to send audio and control commands to a connected audio product. This allows the TV to switch on the audio product when needed, and also to control the volume from the TV remote.

Note: the TV power Control option in the configuration menu is enabled by default but can be disabled if required.

Troubleshooting

No signal shown on the front panel or no audio output from your connected product

- Make sure the HDMI input on your TV supports ARC/eARC
- Make sure the TV is set to use a connected audio system rather than its internal speakers
- Make sure that the audio output of your TV is set to 'Stereo PCM (Uncompressed)'
- Make sure your HDMI cable is compatible with HDMI 1.4 or above

TV will not switch on or control your connected product

- Make sure any relevant CEC and ARC settings have been enabled on your TV
- Make sure TV Power Control mode has been enabled on the EXA. See the Setup Menu section for more details

Reporting an issue

If after following the above troubleshooting steps you still have a problem getting ARC/eARC to work with your product, please contact our support team

USB Audio Connection

Last updated: October 2, 2024 02:17. Revision #14116

The EXA USB Audio input enables the playback of audio from Microsoft Windows or Apple Mac OS X personal computers (and some Linux builds).

When connected via a USB cable, the computer will identify the EXA as an audio device. Specifying the EXA in the computer's audio control panel, will enable it to play audio data either stored locally on the computer or streamed to the computer via a network or the internet.

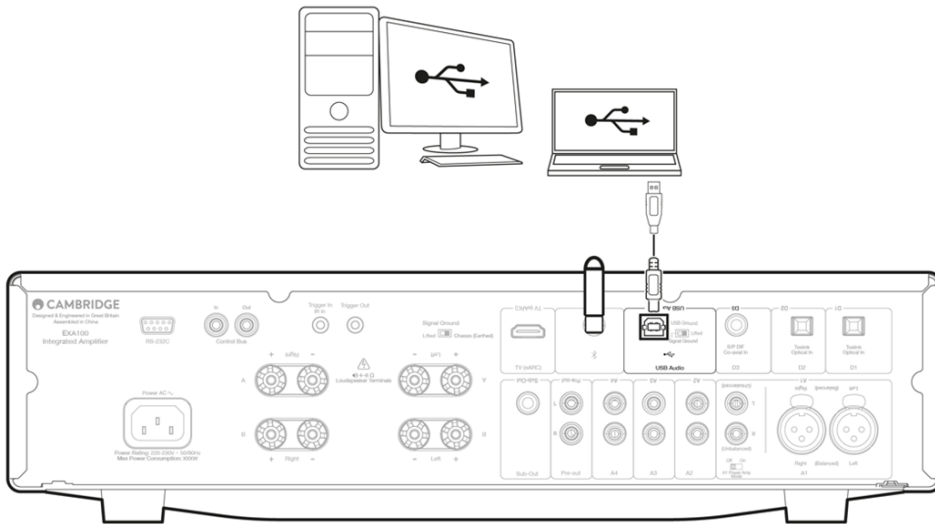

Important Note: Always turn the volume to minimum, switch to another input or turn the EXA off before plugging/unplugging cables to the USB input or whilst booting up/shutting down your PC/Mac.

Note: Always use a high-quality USB 'A to B' cable certified as USB Hi-Speed. USB cable connections longer than 3m may result in inconsistent audio performance.

The EXA is both USB 2.0 (Hi-Speed) and USB 1.1 (Full-speed) USB port compatible.

It should also work with USB 3.0 ports where the PC will simply treat the EXA as if it were a USB 2.0 or 1.1 device.

The EXA supports two USB Audio protocols (not the same as the port types themselves):

- USB Audio Class 1 (which works over USB 1.1 ports and supports up to 24-bit/96kHz)
- USB Audio Class 2 (which requires a USB 2.0 port and can support up to 24-bit/384kHz)

The default configuration is USB Audio Class 2.

How to connect a Windows PC to the EXA via the USB Audio input

With the EXA switched to USB Audio Class 1, the EXA will work with Windows 7 or above and accept audio up to 24-bit/96kHz.

With the EXA switched to USB Audio Class 2, the EXA needs the Cambridge Audio USB Audio 2.0 Driver to be loaded and can then accept up to 24-bit/384kHz.

1. With the EXA in Standby mode and/or the volume set to minimum, connect your PC to the EXA via a USB A to B cable.
2. For the highest quality play back, ensure that the EXA is set to USB 2.0 mode.
See the 'Setup Menu' section for a guide on how to change USB mode. (The default configuration is USB Audio Class 2)
3. Download the Windows USB 2.0 driver.
See the "How do I install the latest USB Audio driver" section below, for a guide on how to download the USB driver.
4. Select the USB Audio source on the front panel of the EXA.
You can do this by pressing the front panel USB Audio button.
5. Choose the EXA as your output speaker via your Windows PC's sound settings.

Note: To ensure you are getting the highest quality playback possible, ensure that the maximum sample rate for the EXA is selected, up to 384 kHz. You can do this via your Windows PC by selecting 'Control Panel' > 'Sound' > 'Speaker Properties' > 'Advanced' Tab, and selecting the maximum sample rate and bit depth from the drop down menu.

How to install the latest USB Audio driver for the EXA100

To install the latest USB Audio driver for your EXA100, please follow the steps below:

1. Download the correct driver for your Windows operating system from - <https://www.cambridgeaudio.com/gbr/en/driver-updates>
2. Unzip the downloaded folder, and double click on the application file to run the installer. This is highlighted in the image below.

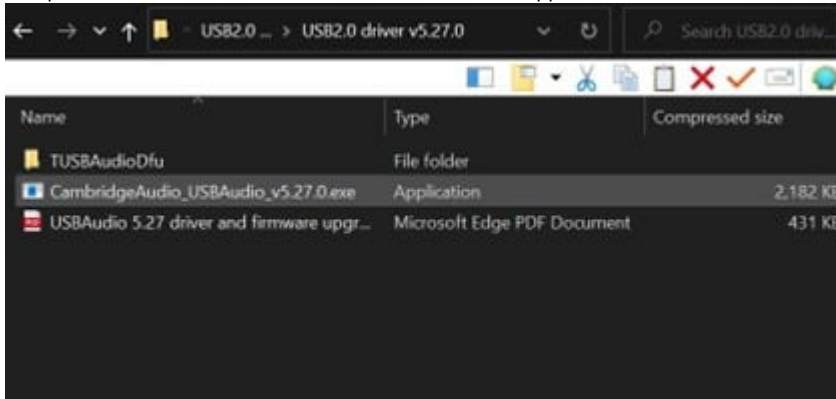

3. Run the installer and follow the instructions.



4. Allow the update to progress, click next, and then finish to complete the installation.

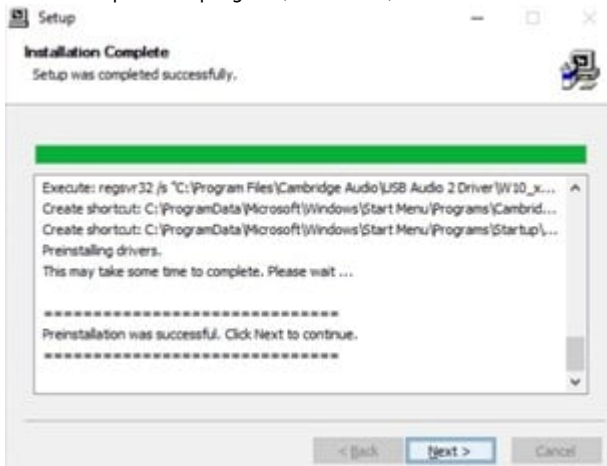

5. Confirm the installation by opening the CA Control Panel and checking the driver version.

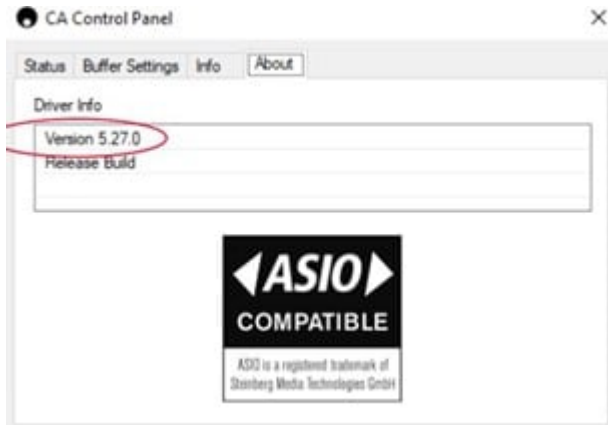

How to connect an Apple Mac to the EXA via the USB Audio input

No extra drivers are required. With the EXA switched to USB Audio 1.0 the EXA will work with the native Mac OS-X 10.5 (Leopard) or above Audio 1.0 driver and accept audio up to 24-bit/96kHz.

With the EXA switched to USB Audio Class 2 the EXA works with the native Mac OS-X 10.5 (Leopard) or above Audio 2.0 driver and can accept audio up to 24-bit/384kHz.

1. With the EXA in Standby mode and/or the volume set to minimum, connect your Mac to the EXA via a USB A to B cable, or C to B cable depending on the USB ports on your Mac.
2. Select the USB Audio source on the front panel of the EXA.
You can do this by pressing the front panel USB Audio button.
3. Choose the EXA as your output speaker via your Mac's sound settings

Note: To ensure you are getting the highest quality play back possible, ensure that the maximum sample rate for the EXA is selected, up to 384 kHz.

This can be done via your Mac by selecting 'Audio Midi Setup > 'Sound' > 'Speaker Properties' > 'Advanced' Tab, and selecting the maximum sample rate and bit depth from the drop down menu.

Use with Linux

For most builds of Linux with the EXA switched to USB Audio Class 1 the EXA will work with the native Audio 1.0 driver and accept audio up to 24-bit/96kHz.

Some very new builds of Linux are now supporting USB Audio Class 2 for which the EXA should be switched to Audio 2.0 to accept audio up to 24-bit/384kHz.

For both cases because Linux builds vary according to their creator's choice of software components including drivers it is not possible to guarantee operation and Audio drivers may need to be loaded.

'Class drivers' as they are called for generic support of Audio Class 1.0 or Audio Class 2.0 devices may be available from the Linux community, we do not supply these.

Note: It is not possible to connect a USB drive or HDD directly to the EXA100 via the 'USB Audio' input. The 'USB Audio' input on the EXA100 will only support a direct connection with a PC or Mac. You will, however, be able to use one of our network players in combination with the EXA100 to do this.

Setup menu

Last updated: October 2, 2024 02:20. Revision #14115

To enter the setup menu

1. Put the EXA in standby mode.
2. Whilst in Standby mode, press and hold the Speaker A/B button until the A/B lights flash alternatively and the sources A1-A4 and the TV input LED light up.

Note: The TV input LED indicates that TV Power Control is enabled by default.

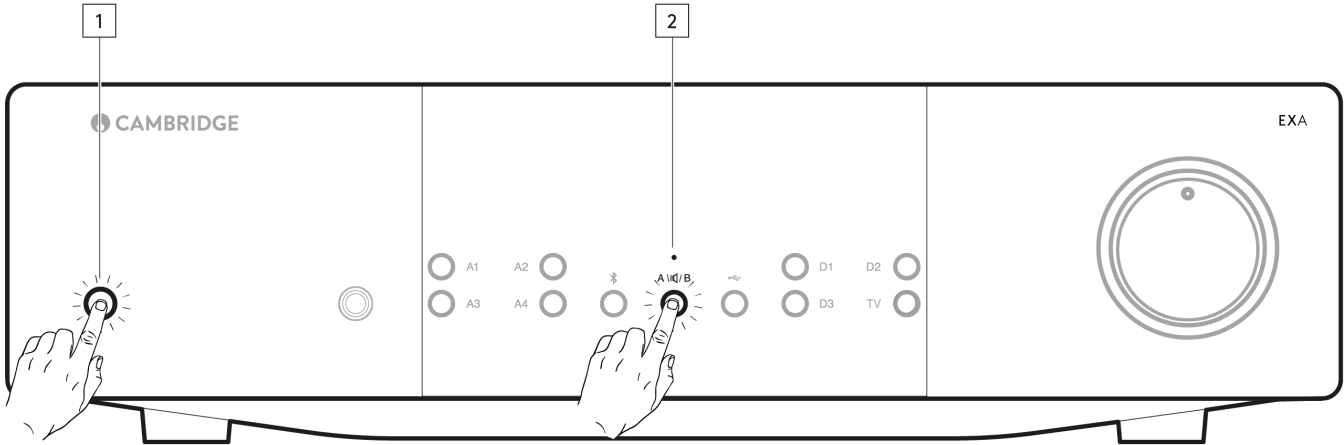

Configuration options

Note: Button selected is represented by a blue light.

Auto power down (APD)

A1 on - Sets the APD time to 20 minutes.

A1 off - Disables the APD (Auto power down) function.

Note: Auto power down is a power down function that automatically switches the EXA into standby mode if there is no audio. The APD time represents the amount of time required for there to be no audio before the EXA is automatically put into the standby mode.

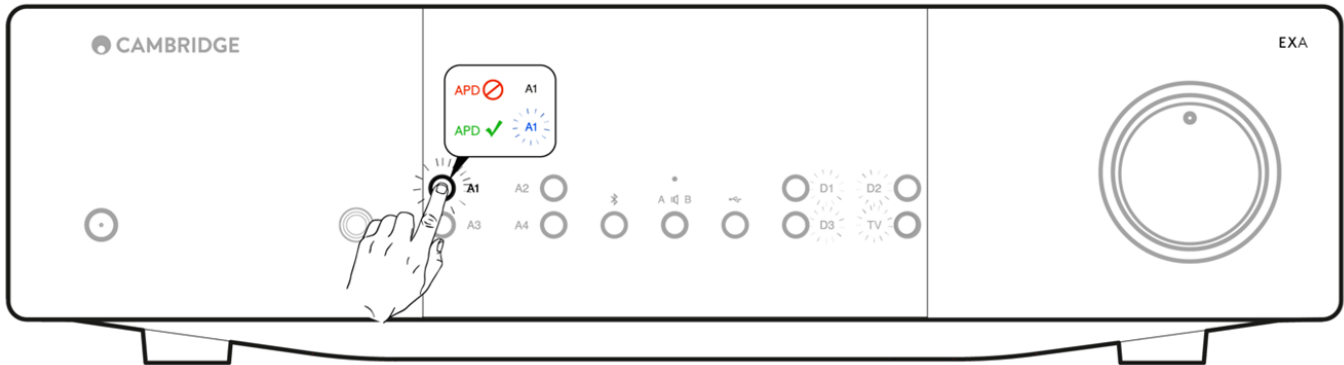

Clipping function

Button A3 selects the amp clip protection mode

A3 on - Clipping function enabled. The volume nudges down if signal clipping is detected.

A3 off - Clipping function is disabled.

USB mode

Button A4 selects the USB Audio mode

A4 on - EXA in USB Audio Class 2 mode.

A4 off - EXA in USB Audio Class 1 mode. Notes:

TV mode

Button A2 selects the TV optimized mode on both D2 and TV inputs.

A2 on - DAC in SYNC mode

A2 off - DAC in ASYNC mode

TV Power Control

TV input button selects TV Power Control via ARC (default is on)

TV LED on - TV Power control is enabled.

TV LED off - TV Power control is disabled.

USB Firmware Update mode

USB input button selects firmware update mode. The rear panel USB connector is switched between USB Audio (default) and firmware update mode. Firmware Update mode is not persistent across a power cycle, the EXA will default to USB switched to USB Audio mode after being switched off.

USB on - Firmware update mode on.

USB off - Firmware update mode off.

Factory reset

This will restore the EXA to its original factory settings.

1. With EXA in standby mode, press and hold the speaker A/B button.
2. When the A/B lights flash, press D1, D3, Bluetooth, D2 in the following sequence:

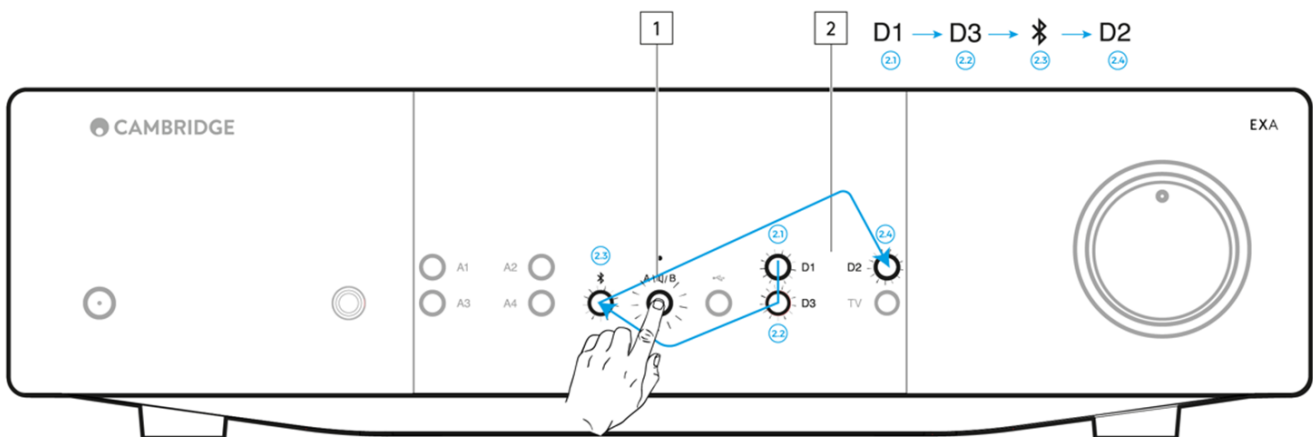

To save settings

Press the Speaker A/B button once to save the current settings and place the EXA back into Standby.

To exit The menu without saving settings

Pressing power button, the EXA will turn to Standby.

Bluetooth

Last updated: October 2, 2024 02:22. Revision #14114

Selecting this source allows the EXA to receive Bluetooth audio from most phones, tablets, and laptops.

The supplied Bluetooth antenna must be inserted into the rear of the unit to enable Bluetooth functionality.

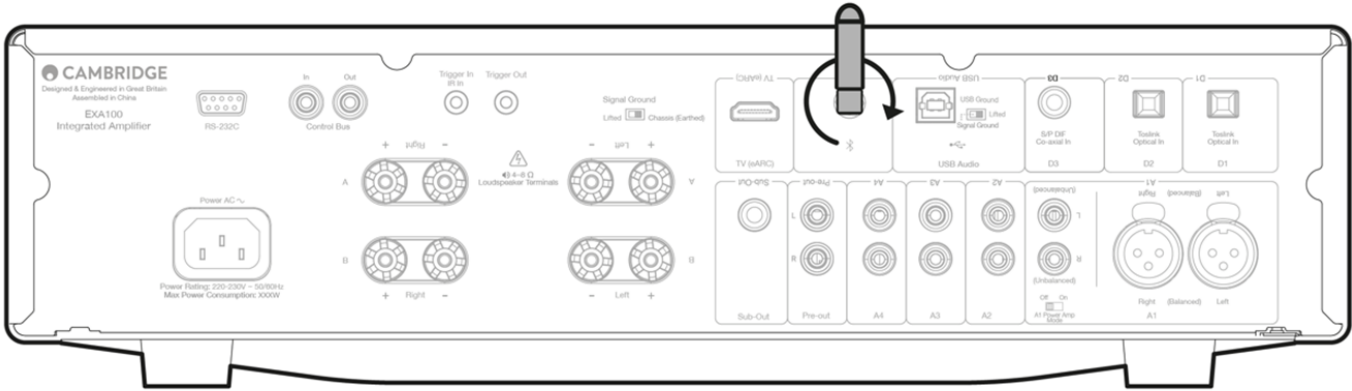

Pairing

To begin streaming high quality music from your device it will first need to be paired with the EXA. Select the Bluetooth source on the EXA to enter discovery mode.

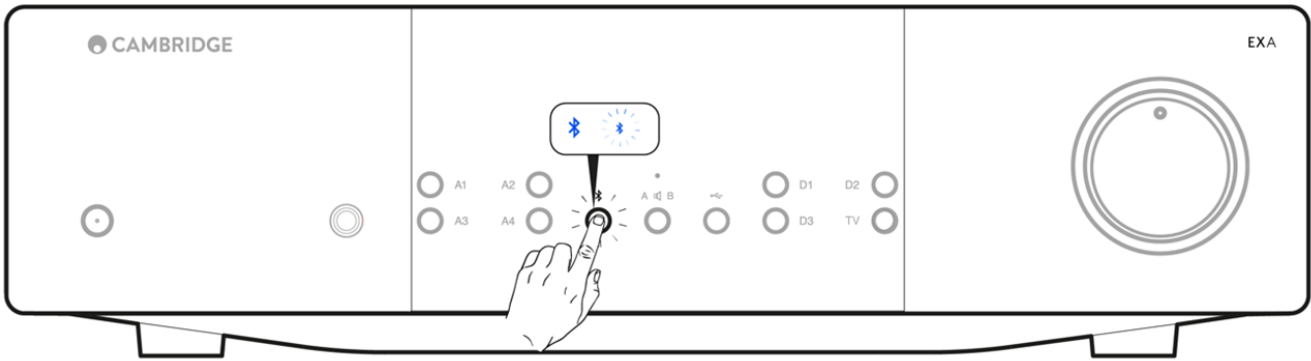

Your device can only be paired and connected to the EXA while the Bluetooth source is selected. This can be done by selecting the Bluetooth source button on the front panel. The Bluetooth source is shown as being selected by the symbol being lit blue.

The EXA is always in discoverable mode when there is no Bluetooth connection. Discoverable mode means that the EXA can be paired to another Bluetooth device.

Bluetooth troubleshooting guide

If you are having problems connecting your Bluetooth device to the EXA, please try the following troubleshooting steps:

- Ensure that the supplied Bluetooth antenna is properly connected to the back of the unit. The EXA100 will be unable to connect to a Bluetooth device without the antenna connected. Try disconnecting and then re-connecting the antenna.
- Ensure that the Bluetooth source has been selected by selecting the Bluetooth button on the front panel.
- Ensure that your Bluetooth device is in pairing mode and not already connected to another Bluetooth unit.
- Forget the EXA from your device's list of discoverable Bluetooth items and start the pairing process again.
- Perform a factory reset on the EXA (see 'Setup Menu' section for more details).

Control Bus

Last updated: October 1, 2024 12:28. Revision #14123

Control Bus allows any compatible Cambridge products to synchronise when powering up the units. The following diagrams show how to connect the EX series using the provided Control Bus cables.

Control Bus also allows the StreamMagic app to control the EXA via an EXN.

StreamMagic app (via EXN)

When using the app to turn the EXN on/off, this will also turn the EXA on/off. The app can also be used to control the volume of the EXA. Connect the EXN control bus out to EXA in. For more information, see the EXN manual.

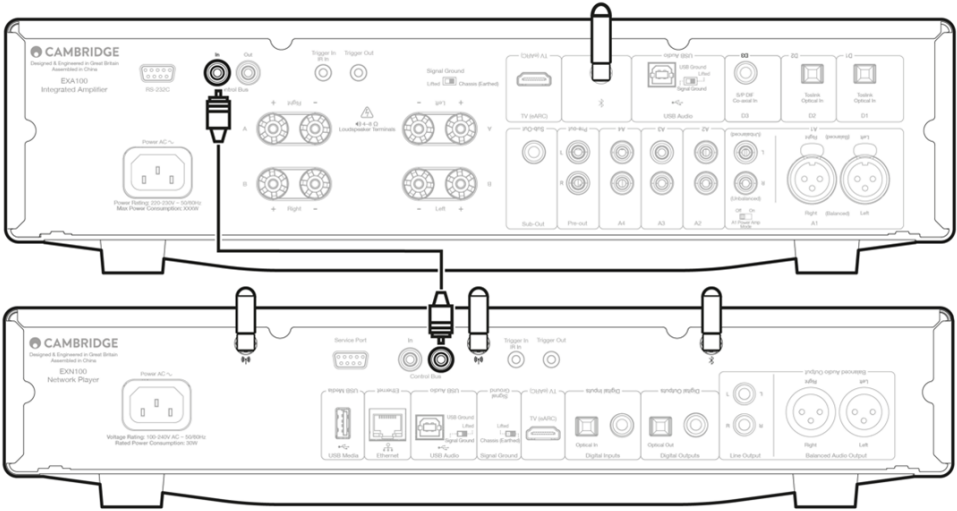

EXA with CXC

When turning the EXA on/off, this will also turn the CXC on/off. Connect the EXA control bus out to CXC in.

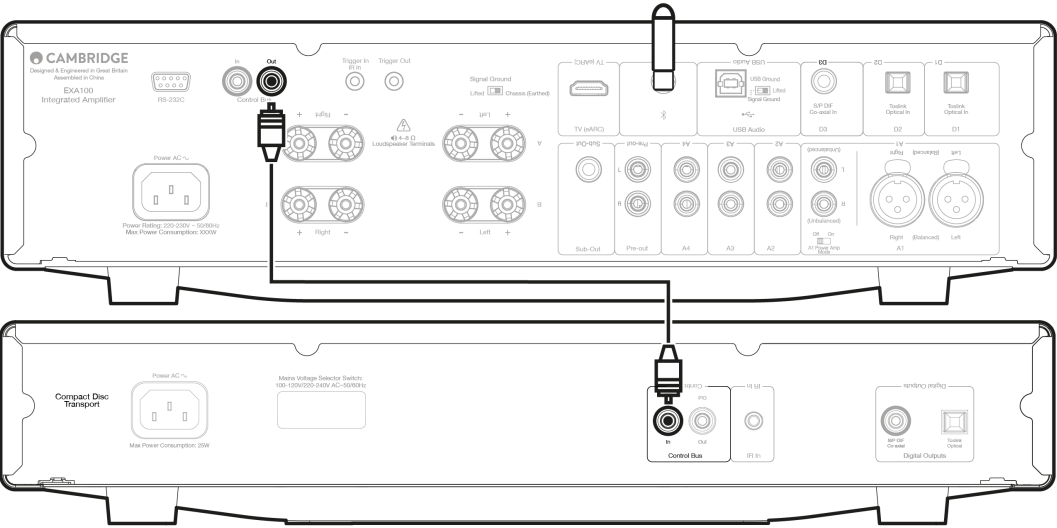

EXA with EXN

Note: Without using the StreamMagic app to control the EXA.

When turning the EXA on/off, this will also turn the EXN on/off. Connect the EXA control bus out to EXN in.

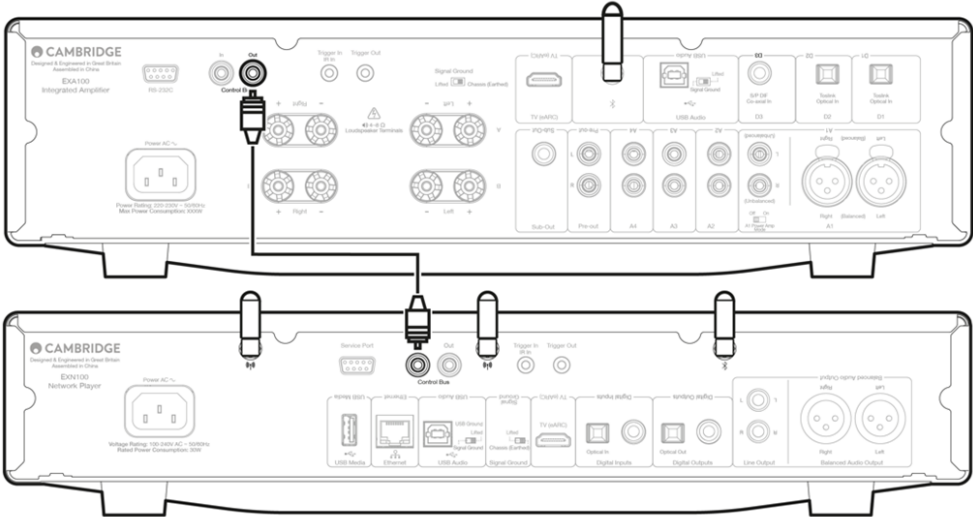

EXA with EXN and CXC

When turning the EXN on/off, this will turn the EXA and CXC on/off.

With all three EX devices, connect the EXN Control Bus out to EXA Control Bus in. Then connect the EXA Control Bus out to CXC Control Bus in.

Note: Do not loop back from the CXC Control Bus out to the EXN Control Bus in.

Control Bus will also need to be enabled and set to 'Amplifier' within the EXN device settings in the StreamMagic app once the app has been connected to the EXN.

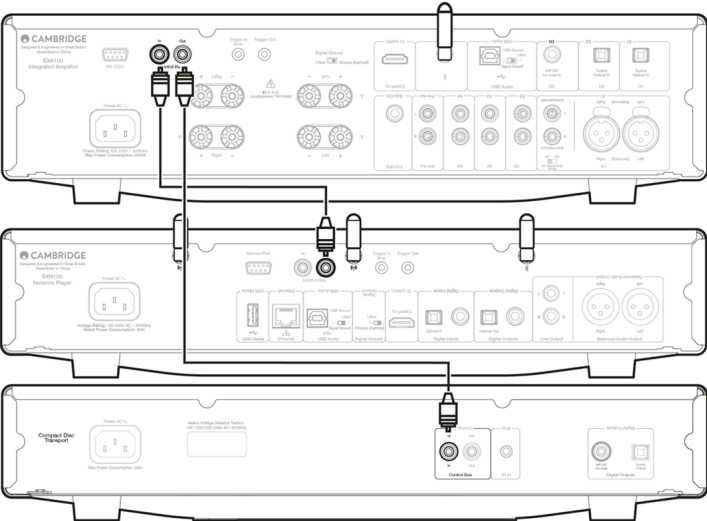

Note: The EXA, EXN and CXC all have an Auto Power Down (APD) function. If APD is enabled and one of the devices is switched on but inactive, the device will automatically power down after the selected APD time. This will then switch off all the other connected devices, due to the Control Bus connection.

If you don't want the devices to go into standby automatically, we would recommend disabling the APD feature on each device.

CAP Protection

Last updated: October 2, 2024 02:31. Revision #14124

Cambridge Audio has developed a proprietary protection system to ensure reliability and a long life for its amplifiers and the speakers they are connected to. This protection system comprises of four main protection methods:

DC detection

Indication - Unit switches off during operation. The front panel speaker A/B white LED's flash in unison with the red LED in the following sequence, one quick flash with long pause between flashes. Read below for more information.

Description - CAP4 offers loudspeaker protection if the output of the amplifier goes to a high constant voltage (DC) because of some internal fault. This is a rare fault although detecting it could just save those expensive loudspeakers.

Remedy - Due to the necessary sensitivity of the DC protection circuit, extremely hard clipping of the amplifier may cause DC protection to be triggered. If this fault occurs, please contact your dealer for service.

Over temperature detection

Indication - Unit switches off during operation. The front panel speaker A/B white LED's flash in unison with the red LED in the following sequence, two quick flashes with long pause between flashes. Read below for more information.

Description - Over temperature is caused by a combination of high listening levels and low impedance speakers. CAP4 includes temperature detection which constantly monitors the heat generated by the output transistors. If the monitored temperature reaches a high level (suitably within the limits of the output devices) the amplifier will automatically switch into a fault mode. The unit should ideally be left for 15 minutes in this state to cool down adequately. If the unit has not fully cooled down then the temperature may reach the limit soon after the amplifier is powered up. If the loudspeaker impedance is low the temperature of the amplifier may rise faster as the amplifier is working harder. If the amplifier is mounted in a cabinet or the ventilation slots are obstructed the over temperature detection may activate/reactivate after a short listening time.

Remedy - The internal temperature of the output transistors has reached the over temperature limit. Leave the unit for 15 minutes to cool down before pressing the Standby button to resume normal operation.

Overvoltage/Overcurrent(V/I) detection

Indication - Unit switches off during operation. The front panel speaker A/B white LED's flash in unison with the red LED in following sequence, three quick flashes with long pause between flashes. Read below for more information.

Description - CAP4 offers V/I (voltage/current) protection by constantly monitoring the output transistors to keep them working inside their Safe Operating Area (SOA). The SOA is a set of limits given by the output transistor manufacturer to ensure reliability. The V/I protection has been incorporated within the amplifier circuitry to provide a fast response to temporary overload conditions. When the V/I protection is triggered the unit will continue to operate but distortion may be heard as the unit protects the output transistors.

Remedy - Reduce the volume. If distortion is still present, check the speaker connections and ratings.

Intelligent clipping detection

Indication - Volume is reduced automatically.

Description - CAP4 has the ability to detect when the amplifier starts to clip or overdrive at its output, which can damage loudspeakers, and degrade the sound. Clipping distortion is caused at high volume levels when the output signal attempts to go outside the maximum voltage that the amplifier can provide, causing the tops of the signal to flatten off. When CAP4 detects clipping the volume will be automatically reduced down until CAP4 detects an undistorted output.

Note: The clipping detection is disabled by default. The clipping detection can be enabled in the Setup menu (see 'Setup menu' section). This can be disabled in setup menu.

If CAP4 is persisting, it is also advisable to check the specifications of your speakers to ensure that they are compatible with the EXA100. Both amplifiers can be used with speakers with an impedance of between 4 and 8 Ohms.

If your connected speakers fall outside of these specifications, then this could also be a reason for CAP4 protection being activated.

Troubleshooting

Last updated: October 2, 2024 02:30. Revision #14125

There is no power

- Ensure the AC power cord is connected securely.
- Ensure the plug is fully inserted into the wall socket and is switched on.
- Check fuse in the mains plug or adaptor.

There is no sound

- Make sure the unit is not in Standby mode.
- Check that the source component is properly connected.
- Check that your speakers are properly connected.
- Make sure the selected speaker A/B light corresponds to the speaker terminals that the loudspeakers are connected to.
- Make sure unit is not in mute mode.
- Check that the correct analogue or digital input button has been selected on the front panel. See the 'Front Panel Connections' section for more information.

There is no sound on one channel

- Check speaker connections.
- Check interconnects.

There is weak bass or diffused stereo imaging

- Ensure that speakers are not wired out of phase.

Speaker A/B and mute light flashing

- See section on CAP4 protection system.

The remote handset does not function

- Check that the batteries have not expired.
- Ensure that nothing is blocking the remote sensor.

There is no audio when connecting a Mac/PC to the USB audio input

- Ensure that all the steps within the 'USB Audio Connection' section of the manual have been followed.
- Ensure that the USB Audio source has been selected by selecting the USB Audio button on the front panel.
- Ensure that your PC/Mac is connected to the USB Audio input with a USB A to B cable.
- If you are connecting a PC and using the EXA in USB Audio Class 2, make sure that the correct USB driver is downloaded. The driver is available from www.cambridgeaudio.com/gbr/en/driver-updates.
- If you have downloaded a Cambridge Audio USB 2.0 Driver, ensure that the EXA is set to USB Audio Class 2 in the Setup Menu.

There is no audio when connecting a TV to the EXA

- The EXA is unable to decode a Dolby or Surround signal, ensure that the audio settings on your TV are set to PCM or Stereo.
- Ensure the correct input has been selected on the EXA.
- Ensure the EXA has been selected as the external speaker in your TV's settings.
- If you have connected your TV to the EXA's eARC input, ensure all relevant eARC/ARC settings have been enabled on your TV.

There are dropouts in audio when connected to a TV via Toslink

- Please see the 'Getting Connected' > 'Connecting a TV' section in the manual.

Technical specifications

Last updated: September 27, 2024 03:50. Revision #14126

Continuous power output

100W RMS into 8 Ohms, 155W RMS into 4 Ohms

DAC

ES9018K2M

THD (unweighted)

<0.002% 1kHz at rated power(8 Ohms)

<0.02% 20Hz - 20kHz at rated power (8 Ohms)

Frequency response

<3Hz - >40kHz +/-1dB

S/N ratio (Ref 1W into 8 OHM)

>91 dB

S/N ratio (Ref full power)

>105 dB

Input sensitivity

Input A1-A4 (unbalanced) 395mV RMS

Input impedances

Input A1 (balanced) 100 kOhm

Input A1-A4 (unbalanced) 45 kOhm

Inputs

Balanced, Unbalanced, Coax SPDIF, TOSLINK, Bluetooth, USB Audio, eARC

Outputs

Speakers, Headphone, Preamplifier Output, Sub Output

Power amp damping factor

>160 at 1kHz into 8 Ohm

USB audio input

USB Type B conforming to USB Audio Class 1 or USB Audio Class 2 (user selectable)

Compatibility

USB Audio Class 1: Up to 24-bit 96kHz (asynchronous)

USB Audio Class 2: Up to 24-bit 384kHz (asynchronous) and up to DSD-256

Bluetooth

5.0 A2DP/AVRCP supporting SBC, aptX and aptX HD codecs

TOSLINK

16/24-bit 32-96kHz

Coax SPDIF

16/24-bit 32-192kHz

Max power consumption

1200W

Standby power consumption

<0.5W

Dimensions

115 x 430 x 341mm (4.5 x 16.9 x 13.4")

Weight

12.8kg (28.2Lbs)

Frequently Asked Questions (FAQ)

Last updated: October 2, 2024 02:34. Revision #14113

How do I select the Balanced or Unbalanced inputs on the EXA?

On the EXA, pressing the A1 input selection button will toggle between the balanced and unbalanced inputs. The balanced input is shown by A1 being lit orange, while the unbalanced input is shown by A1 being lit blue.

Please ensure that the correct input is selected on the EXA, depending on how your EXA is connected. If the wrong input is selected, then there will be no sound from the amplifier.

Can I connect an external HDD to 'USB Audio In' on the EXA100?

No, there is no way to connect a USB drive or HDD directly to the EXA100 using its 'USB Audio' input. The 'USB Audio' input on the EXA100 will only support a direct connection with a PC or Mac. You will, however, be able to use one of our Network Players in combination with the EXA100 to do this.

Why can't I adjust the volume of the EXA100 with my mobile device when connected via Bluetooth?

When using Bluetooth with the EXA100, the amplifier's volume control takes over from the mobile devices' volume. The mobile device then produces a Bluetooth stream of fixed level volume, which is then adjusted at the amplifier's end.

It is normal behavior for some mobile device not to be able to control the volume of the EXA100 when connected via Bluetooth. Volume adjustments can be made on the amplifier itself, using either the remote control or the front panel volume knob.

What is the crossover frequency on the EXA100?

The EXA100 has a low pass filter of 2.3 kHz applied at the Sub Out output. This is so that there is minimal phase added by the EXA at the Sub Out frequencies. This allows you to set your own crossover frequency on the Subwoofer itself.

What would the power output of the EXA be if I connect two pairs of speakers?

When you connect two pairs of speakers to an amplifier, the combined impedance is halved. So, when two pairs of 8Ω (Ohm) speakers are connected, the overall impedance becomes 4Ω, even though the individual impedance for each speaker remains unchanged at 8Ω. The EXA100 outputs are rated at 100 RMS at 8Ω which is increased to 155W at 4Ω.

It is not recommended to connect 2 pairs of 4 Ohm or 6 Ohm speakers to the EXA100, as the impedance is halved meaning the impedance will be 2 Ohms or 3 Ohms respectively. This could result in the amplifier being driven too hard and CAP4 protection being activated, or damage being done to the amplifier and/or speakers.

Will the EXA100 playback 32-bit files via the USB Audio input?

Whilst the EXA's hardware is capable of handling 32-bit audio via the USB Audio input, the USB interface is reporting the host to be only 24-bit capable.

If you attempt to play 32-bit files, the USB driver will convert them to 24-bit by removing the least significant information.