



Power Amplifier
Amplificateur de Puissance
Усилитель мощности

M-5000

Owner's Manual
Mode d'emploi
Bedienungsanleitung
Bruksanvisning
Manuale di istruzioni
Manual de instrucciones
Gebruikershandleiding
Инструкция По Эксплуатации

English

Français

Deutsch

Svenska

Italiano

Español

Nederlands

Русский

Thank you and congratulations on your purchase of this Yamaha product.

- ◆ You can enjoy the high-quality stereo sound of this power amplifier at home.
- ◆ This Owner's Manual describes the unit's features and connection procedures.
- ◆ To use the product properly and safely, we suggest that you read this manual and Safety Brochure (separate booklet) thoroughly.
Keep the manual in a safe, accessible place for future reference.

You can download a PDF version of this manual from the following Yamaha website.

<https://download.yamaha.com/>

Features

- ◆ Full floating and balanced transmission from input to output
- ◆ High-rigidity lever selectors
- ◆ Stable mechanical grounding construction dramatically lessens the impact of external vibrations
- ◆ Left-right symmetrical design
- ◆ Large power supply with four separate circuits, and large capacitors of $33000 \mu\text{F} \times 4$
- ◆ Newly-designed brass spiked feet
- ◆ Powerful 400 W/8 Ω output driven in monaural

About this manual



- ◆ The illustrations as shown in this manual are for instructional purposes only.
- ◆ The company names and product names in this manual are the trademarks or registered trademarks of their respective companies.
- ◆ “ **WARNING**” describes precautions to be followed to avoid the possibility of serious injury or even death.
- ◆ “ **CAUTION**” describes precautions to be followed to avoid the possibility of injury.
- ◆ “**NOTICE**” describes precautions to be followed to avoid the possibility of malfunction/damage to the product, or damage to data.
- ◆ “**Note**” describes supplemental information about the product.
- ◆ Before starting to use the product, please be sure to read the separate “Safety Brochure”.

Table of contents

Features	2
About this manual.	2
Supplied accessories	4
Maintenance	4
Mirror-finish side panels.	4
Surfaces other than the mirror-finish side panels	4

Part Names and Functions

Front panel	6
Rear panel	8
Balanced and unbalanced connections	10

Connections

Connecting a preamplifier.	12
Trigger connections.	13
Basic speaker connections.	14
Connecting speaker cables	16
Using standard speaker cables.	16
Using Y-shaped lug cables	17
Bi-wiring connections	18
Bi-amp connections.	20
Bridge connections	22
Connecting the power cord	24

Reference Materials

General specifications	26
Block diagram	27
Audio characteristics	28
Total harmonic distortion (8Ω).	28
Total harmonic distortion (4Ω).	28
Total harmonic distortion (monaural 8Ω)	29
Frequency response	29
Troubleshooting	30
Index	32

Supplied accessories

Please make sure that the following accessories are included in the package.

- Power cord
- System cable
- Owner's Manual (this book)
- Safety Brochure (separate booklet)



WARNING

Do not use the supplied power cord for other devices.

Maintenance

To use this product for an extended period of time, we recommend that you maintain it regularly.



WARNING

- Check the power cord regularly to see if it is dusty. If so, wipe off the dust completely. Otherwise, fire or electric shock might be caused.
- Do not use aerosol or flammable gas spray for cleaning or lubrication. Otherwise, flammable gas will build up inside the unit, causing possible explosion or fire.

NOTICE

- Use a dry soft cloth to clean the unit. Using cleaning agents, such as benzene or thinner, detergent, or chemically-treated cloth might cause color changes or deterioration of the surface. If the surface gets very dirty, damp a cloth with detergent (diluted with water), wring the cloth tightly, and wipe off the dirt.
- If you wipe the surface area in the vicinity of the Yamaha logo with force, the logo might peel off or fiber from the cloth might stick to the surface.

Mirror-finish side panels

We recommend that you use a cleaning cloth such as those made for pianos. If the surface is very dirty, use a soft cloth that is damp with water and wrung tightly.

Surfaces other than the mirror-finish side panels

Wipe other surfaces using a soft dry cloth. If the surface gets very dirty, dampen a cloth with detergent diluted in water, wring the cloth tightly, and then wipe the dirt from the surface.

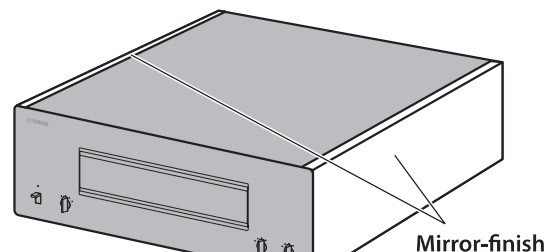

Part Names and Functions

This section describes the names and functions of the parts on the front and rear panel.

Front panel

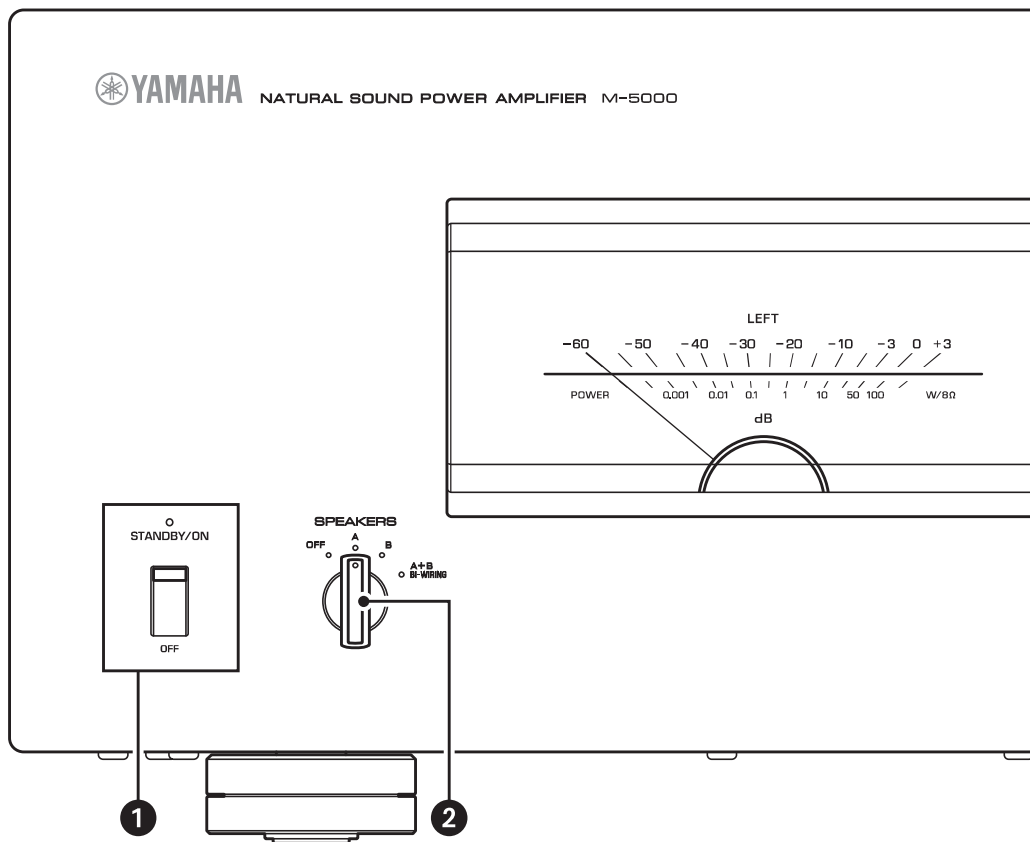

1 STANDBY/ON/OFF (Power) switch/indicator

Turns the power to the unit on or off.

STANDBY/ON: Turns the power to the unit on.

OFF: Turns the power to the unit off.

Power status	Indicator
On mode	Lit brightly
Standby mode	Lit dimly
Off mode	Off

The unit will enter standby mode in one of the following events:

- If the unit is powered on but not operated for eight hours while the auto power standby function is turned on, or
- If you turn off the power to the device that is connected to this unit's TRIGGER IN jack.

For more information, refer to “7 AUTO POWER STANDBY switch” in the “Rear panel” section (page 9) and to “Trigger connections” (page 13).

Note

After you turn on the unit, it will take a few seconds before the unit can reproduce sound.

NOTICE

If you plan not to use the unit for an extended period of time, be sure to unplug the power cord from the AC outlet. Even when the STANDBY/ON/OFF (Power) switch is turned off (the power indicator is dark), a minimal amount of electric current is still flowing to the unit.

2 SPEAKERS selector

Turns on or off two sets of speakers connected to the SPEAKERS A and B terminals on the rear panel.

OFF: Both sets of speakers are off.

A: The set of speakers connected to the A terminal is on.

B: The set of speakers connected to the B terminal is on.

A+B/BI-WIRING: Both sets of speakers are on.

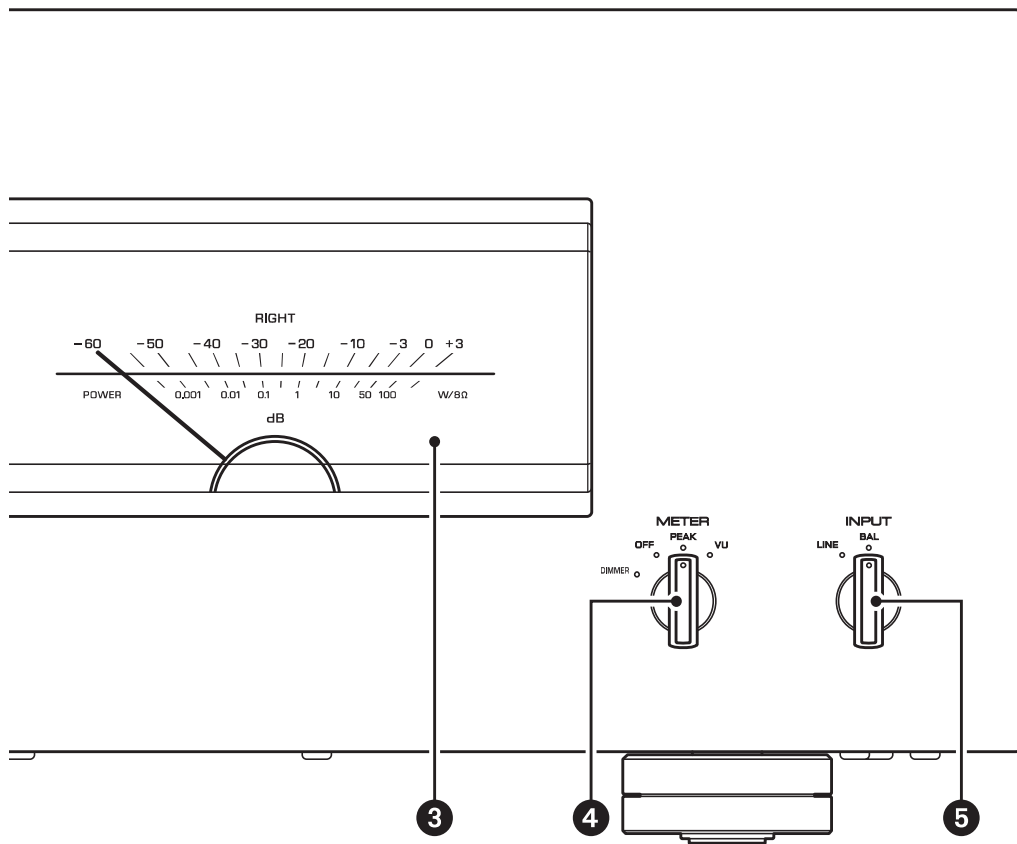

NOTICE

Make sure that the impedance of each speaker is appropriate for the system configuration. For more information, refer to “Basic speaker connections” (page 14), “Bi-wiring connections” (page 18), “Bi-amp connections” (page 20), and “Bridge connections” (page 22).

3 Meter display (LEFT/RIGHT)

Indicates the audio output level of the left and right channels.

4 METER selector

Switches the meter display type to OFF, PEAK, or VU.

DIMMER: Adjusts the brightness of the meter display. The brightness will change slowly between the brightest and darkest (off). When you select the meter type by turning the METER selector, the brightness at that point will be used for the display.

OFF: Turns off meter operation and display illumination.

PEAK: Switches the meter display type to a peak level meter. The peak level meter shows the highest instantaneous level of an audio output signal.

VU: Switches the meter display type to a VU (Volume Unit) level meter. The VU level meter shows an effective audio output value that represents the way sound is perceived by human ears.

5 INPUT selector

Enables you to select jacks to play back an audio source.

LINE: Audio source input from the LINE jacks will be played back.

BAL: Audio source input from the BAL jacks will be played back.

Rear panel

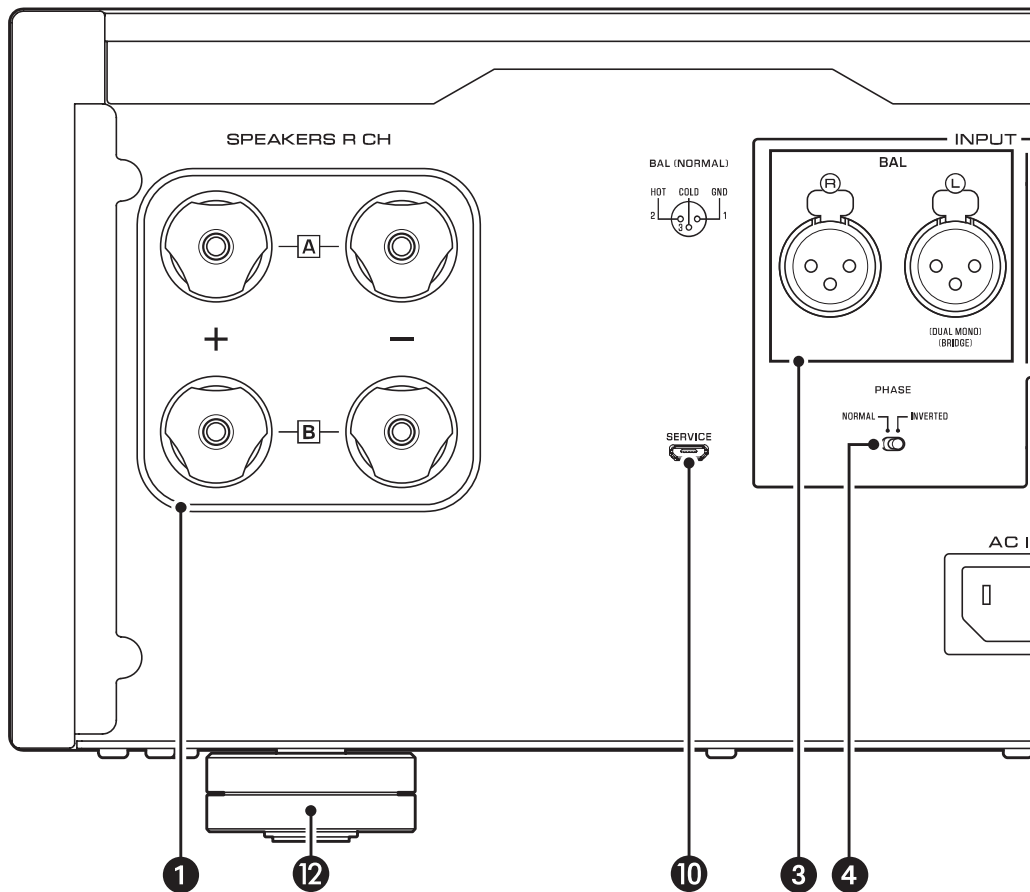

Note

For information regarding the connection procedure, refer to "Connections" (page 11).

1 SPEAKERS R CH output terminals

2 SPEAKERS L CH output terminals

Use the included speaker cables to connect speakers to the terminals. For information regarding the connection procedure, refer to "Connections" (page 11).

3 BAL input jacks

These are XLR-type balanced input jacks. Connect your preamplifier here. Set the PHASE selector appropriately for the connected preamplifier.

4 PHASE selector

Sets the position (polarity) of the HOT pin at the BAL input jacks according to the connected preamplifier. For more information, refer to "Balanced and unbalanced connections" (page 10).

NORMAL: Pin #2 is specified as HOT.

INVERTED: Pin #3 is specified as HOT.

Refer to the instruction manual for the connected component to find out the position of the HOT pin at the balanced output jacks on the component.

5 LINE input jacks

These are RCA-type unbalanced input jacks. Connect your preamplifier here.

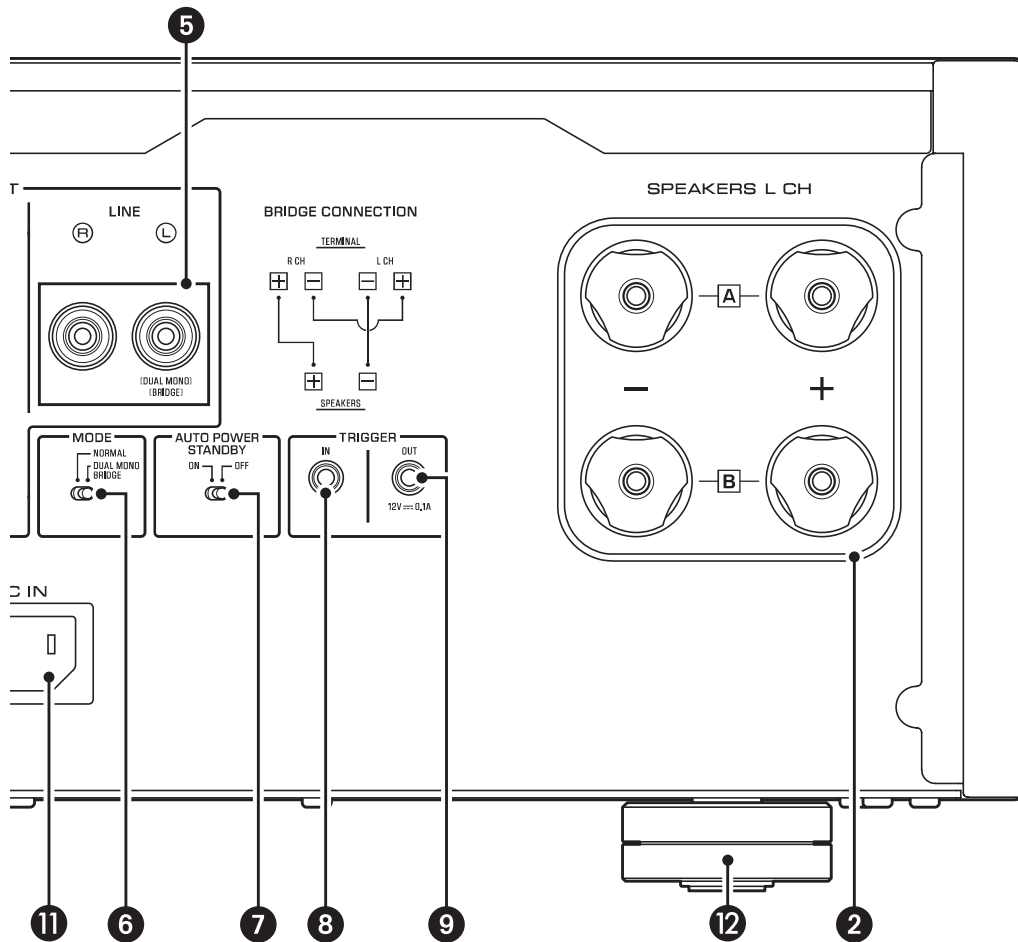

6 MODE selector

Switches the speaker output between stereo and monaural. For more information, refer to “Basic speaker connections” (page 14), “Bi-wiring connections” (page 18), “Bi-amp connections” (page 20), and “Bridge connections” (page 22).

NORMAL: The unit is used as a stereo amplifier. This is the standard setting.

DUAL MONO/BRIDGE: The unit is used as a monaural amplifier. Select this setting for bi-amp or bridge connections.

7 AUTO POWER STANDBY switch

ON: The unit enters standby mode automatically if it is powered on but not operated for eight hours. This function is disabled if the system cable is connected to the TRIGGER IN jack.

OFF: The unit does not enter standby mode automatically.

8 TRIGGER IN jack

9 TRIGGER OUT jack

Used to connect a component that supports the trigger function so that you can control the unit’s power on and off from that component. For more information, refer to “Trigger connections” (page 13).

10 SERVICE jack

This jack is used to test the product.

11 AC IN jack

Connect the supplied power cord here. For more information, refer to “Connecting the power cord” (page 24).

12 Feet

If the unit is unstable, adjust the height of the feet as needed by rotating them.

Balanced and unbalanced connections

This unit features balanced input jacks (BAL) and unbalanced input jacks (LINE).

NOTICE

Do not use balanced and unbalanced connections between two components simultaneously. Doing so would create a ground loop that could generate static and noise.

Balanced connection

A balanced connection is a great advantage against external noise. For a balanced connection, use a cable with male XLR connectors. When connecting a cable, be sure to align the pins on the connector with the holes on the jack, and then insert the connector into the jack until you hear a click. To remove the cable, while pressing and holding down the lever on the BAL jack, pull out the male XLR connector from the jack.

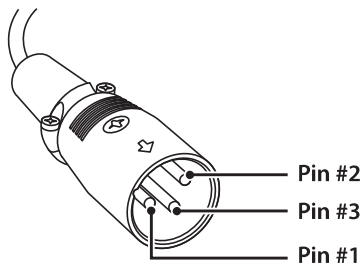

When making a balanced connection, you must set the polarity correctly. To set the polarity, use the PHASE selector on the rear panel.

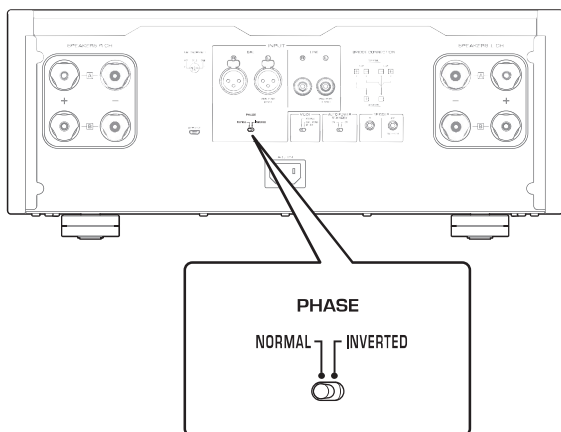

If the PHASE selector is set to NORMAL, pin #2 becomes HOT.

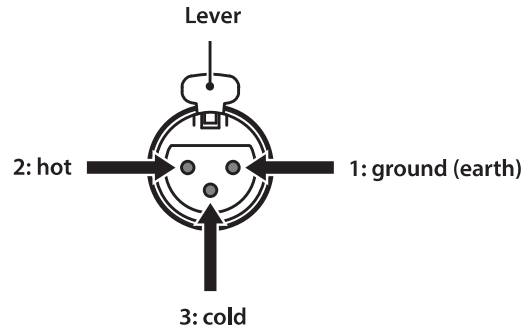

If the PHASE selector is set to INVERTED, pin #3 becomes HOT.

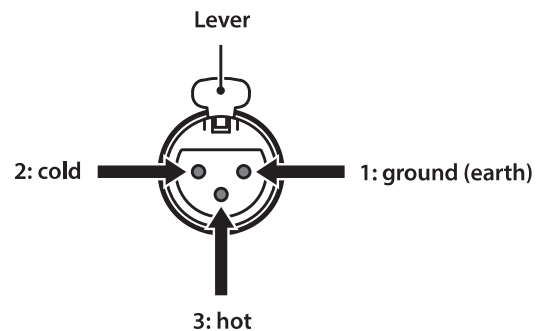

Note

Select NORMAL (pin #2 is HOT) for a Yamaha player or preamplifier.

Unbalanced connection

For an unbalanced connection, use RCA-type pin cables. They do not transmit phase information.

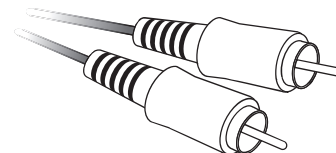

Connections

This section explains how to connect the unit to a preamplifier and speakers.

**CAUTION**

Turn off the power to all components before making any connections.

NOTICE

Before you connect external components, read and follow the instruction manuals for those components. Otherwise, this unit or external components might malfunction.

Connecting a preamplifier

Connect your preamplifier to the unit's input jacks. For this connection, use XLR-type balanced cables or RCA-type unbalanced cables.

Balanced connection

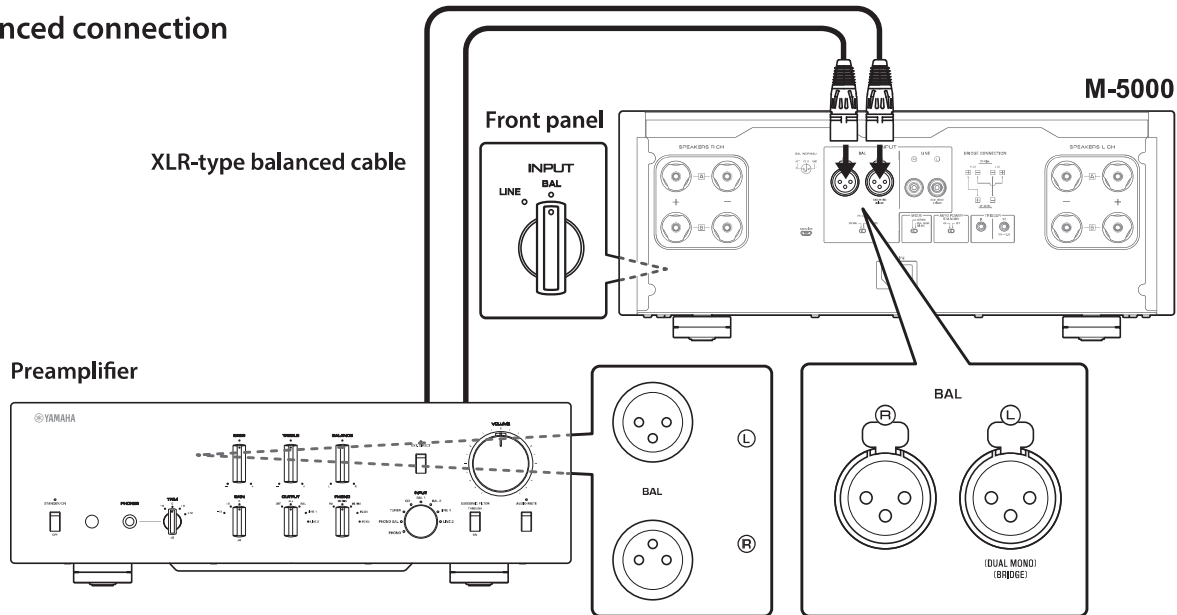

Unbalanced connection

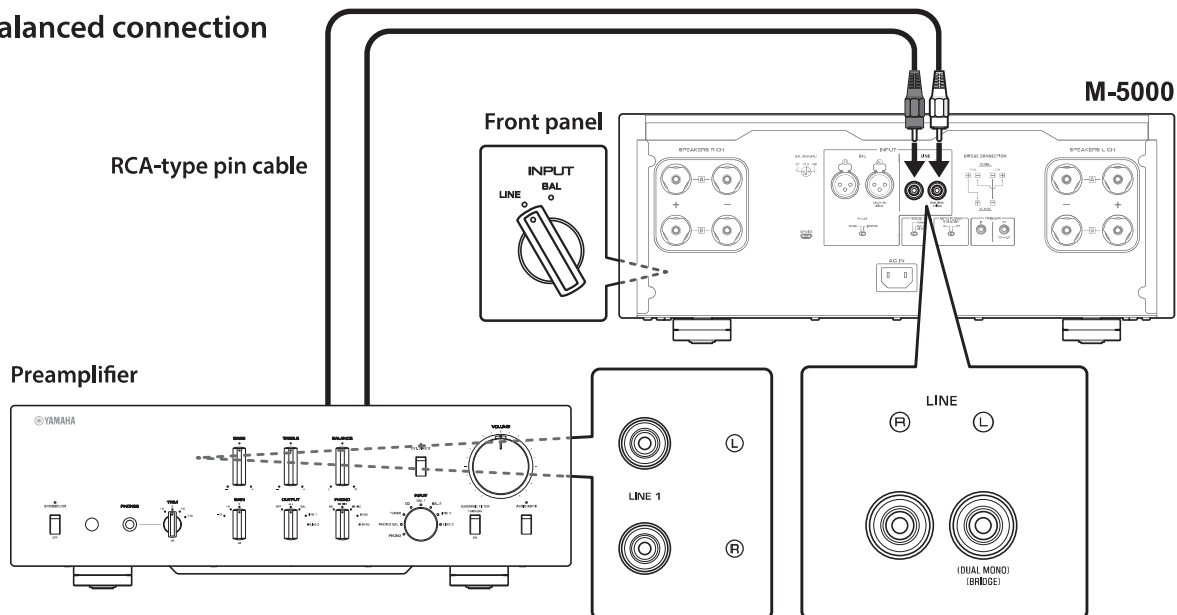

NOTICE

The unit's volume level is fixed. Do not connect a component that does not feature volume adjustment to the unit's input jacks. Otherwise, a loud sound might be emitted, resulting in malfunction of the unit or damage to the speakers.

Note

- If the preamplifier supports both balanced and unbalanced connections, use a balanced connection.
- Do not use balanced and unbalanced connections between two components simultaneously. Doing so would create a ground loop that could generate static and noise.

Trigger connections

You can control the unit's power on and off in sync with a connected Yamaha component, such as a preamplifier or AV receiver.

Use the supplied system cable to make connections as shown in the following diagram.

Example (one M-5000 unit is used)

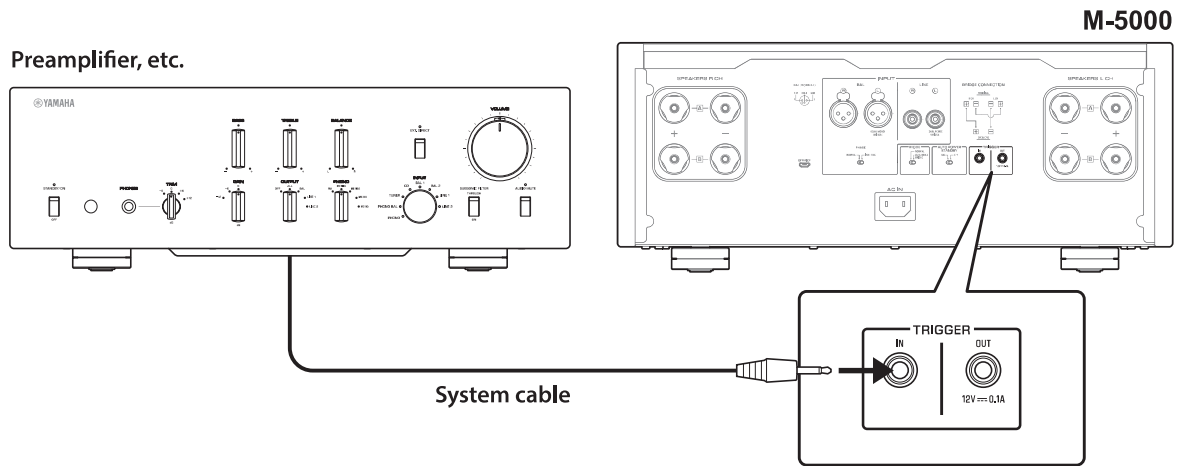

Example (two M-5000 units are used)

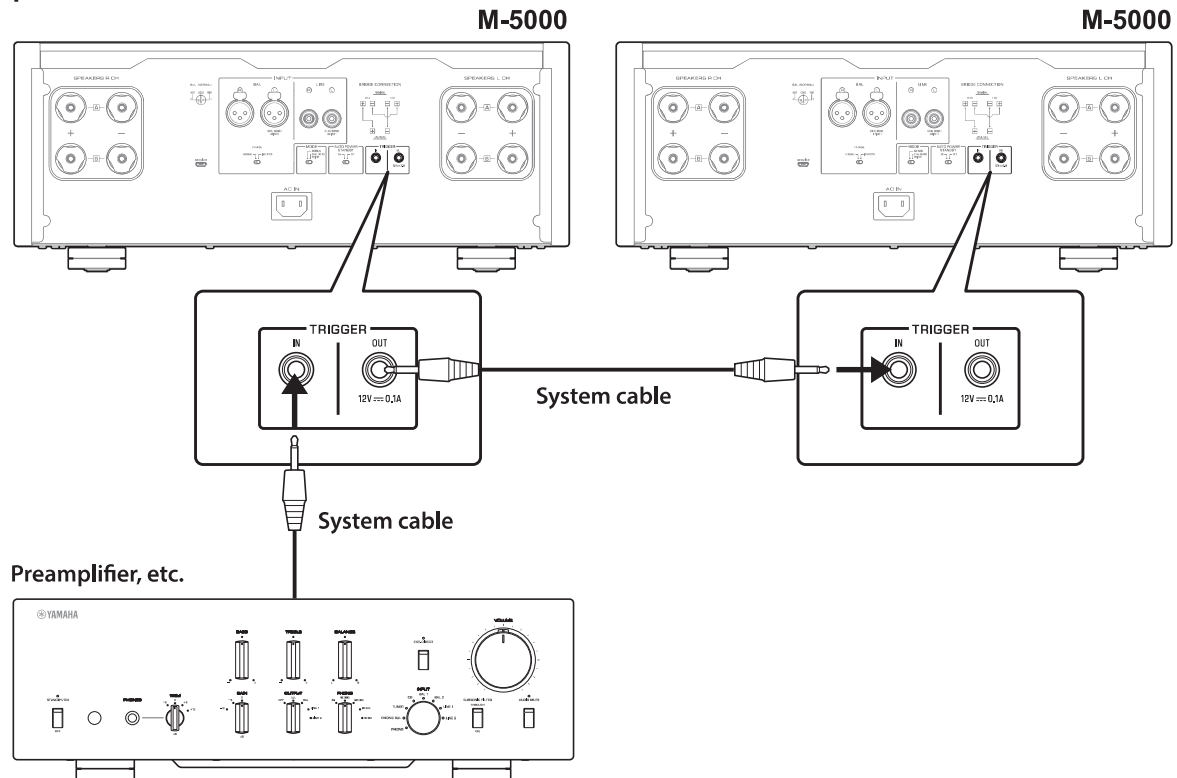

To control the unit in a trigger connection configuration, set the STANDBY/ON/OFF (Power) switch to STANDBY/ON.

When the power to the connected component is turned on, the power to this unit is also turned on. When the power to the connected component is turned off, this unit enters standby mode.

Note

When the power switch on this unit is turned OFF, the power to the unit will not be triggered.

Basic speaker connections

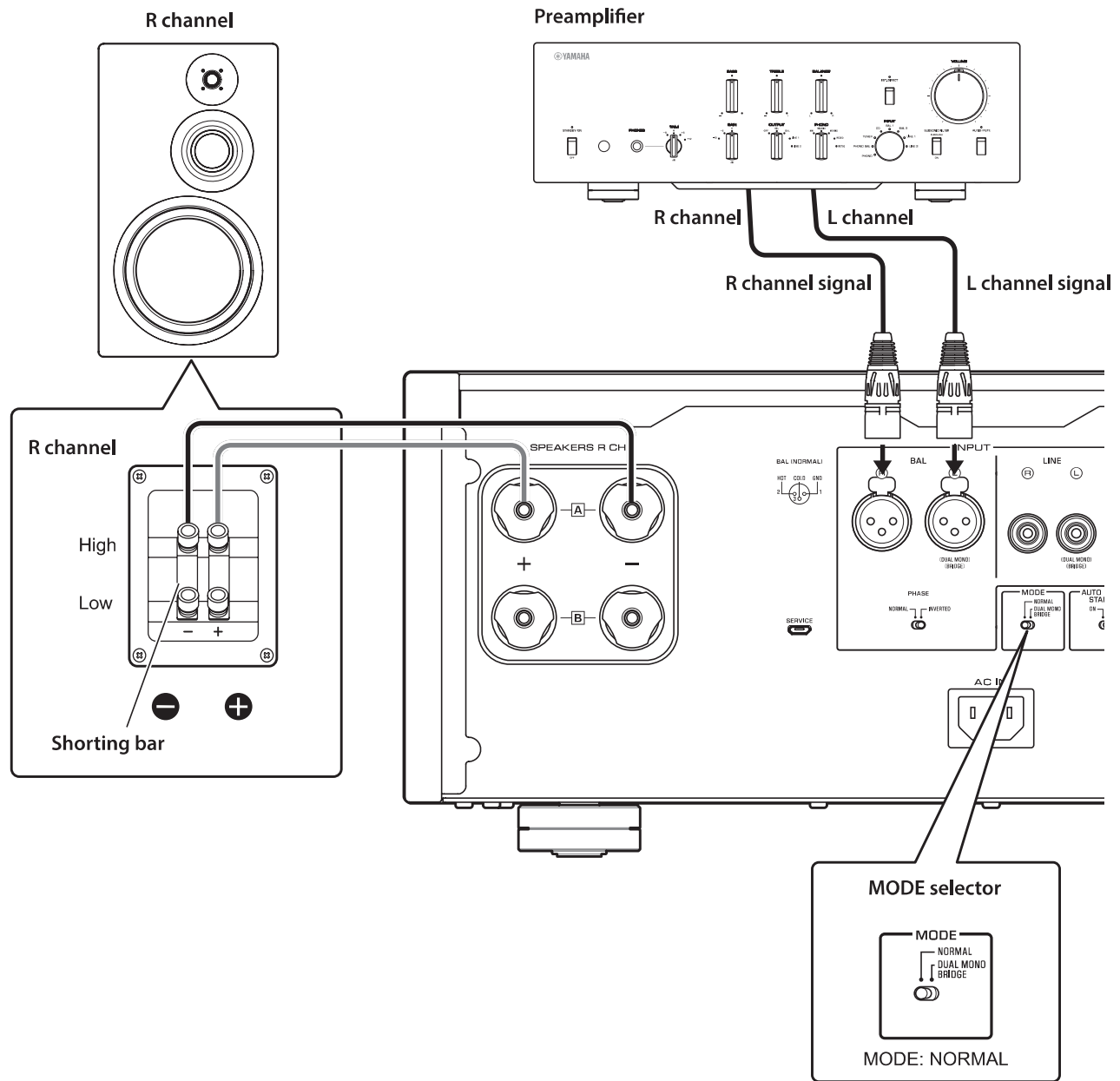

- 1 Turn off the power to the unit and all connected components.
- 2 Set the MODE selector on the rear panel to NORMAL.
- 3 Set the SPEAKERS selector on the front panel to A, B, or A+B BI-WIRING.
The diagram shows the selector set to A.
- 4 Connect the power amplifier to the "+" and "-" terminals of the speakers.

CAUTION

Be sure to use speakers that feature the impedance shown in the table below.

Speaker impedance

SPEAKERS selector	A	B	A+B
Basic connection/ Bi-wiring connection	4Ω or higher		8Ω or higher
Bi-amp connection	4Ω or higher		8Ω or higher
Bridge connection	8Ω or higher		16Ω or higher*

* Excluding models for U.S.A. and Canada

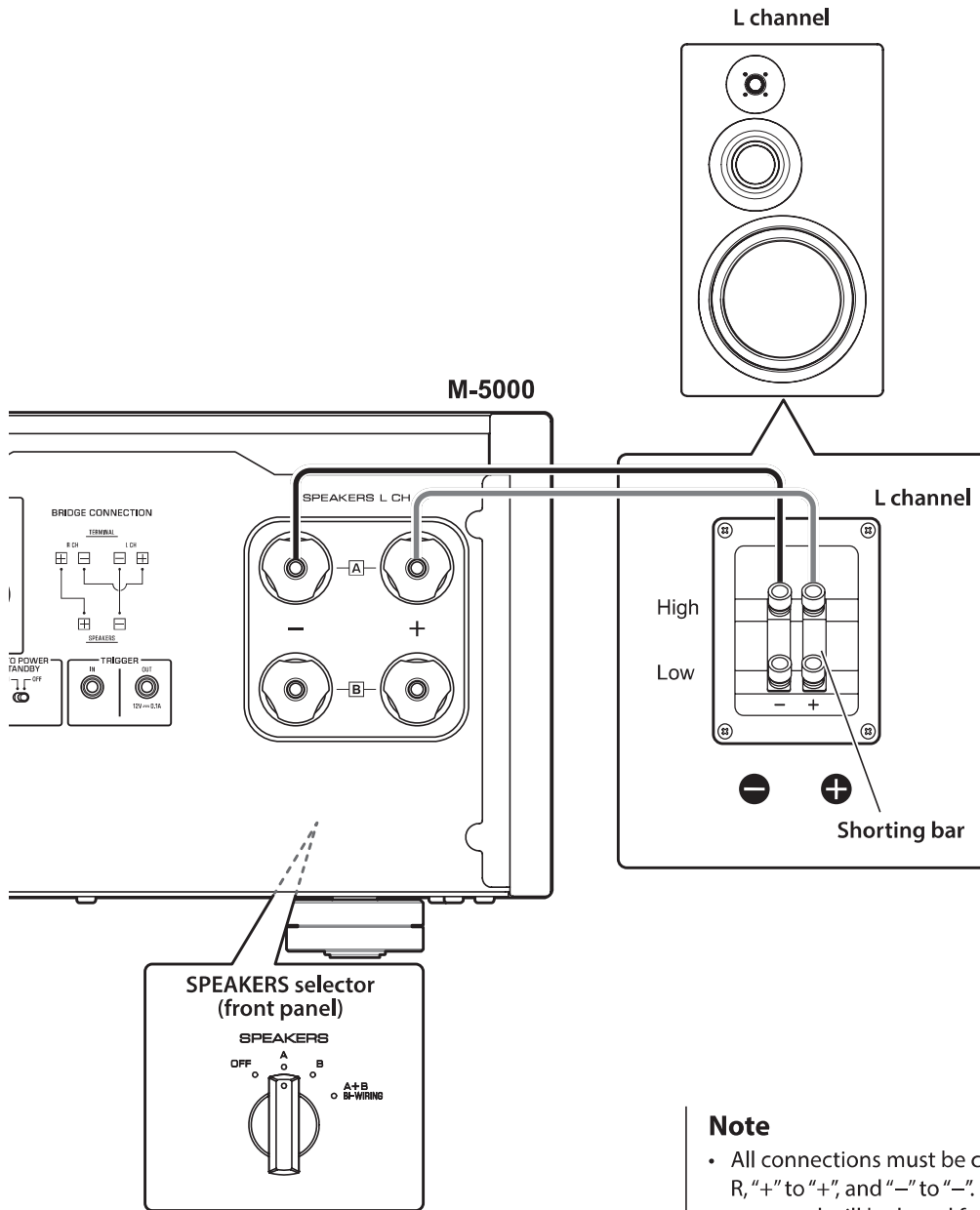

CAUTION

Before turning the power back on to the source component, first lower the volume level on that component.

NOTICE

- Do not let the bare speaker wires touch each other, nor let them touch any metal part of this unit. Otherwise, the unit and/or the speakers might be damaged.
- Do not connect an active subwoofer to this unit. Connect the subwoofer to the preamplifier.

Note

- All connections must be correct: L (left) to L, R (right) to R, "+" to "+", and "-" to "-". If the connections are faulty, no sound will be heard from the speakers. Also, if the polarity of the speaker connections is incorrect, the sound will be unnatural and lack bass.
- Because this power amplifier is of the floating balanced type, the following types of connections are not possible.
 - Connecting between two "+" (or two "-") terminals of the left and right channels (Fig. 1).
 - Connecting each "-" terminal of the unit's left and right channels to the opposite channel speakers (cross connection, Fig. 2).
 - Connecting the left/right channel "-" terminals (or accidentally allowing them to come in contact) with the metal part of the rear panel of this unit.

Figure 1

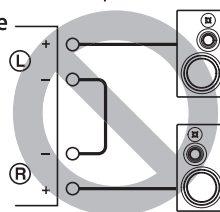
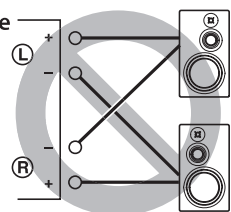

Figure 2



Connecting speaker cables

Using standard speaker cables

- 1** Remove approximately 10 mm (0.4 in) of insulation from the end of each speaker cable, and twist the exposed wires together tightly to prevent short circuits.

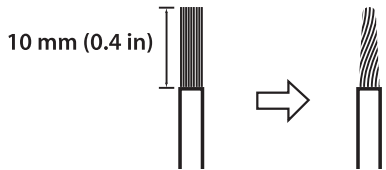

- 2** Unscrew the knob on each SPEAKERS terminal, and then insert the bare wire into the side hole on the terminal.

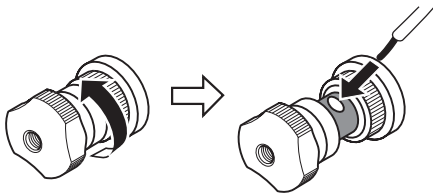

Diameter of the speaker cable wire hole: 6.0 mm (0.24 in)

- 3** Tighten the knob.



CAUTION

- Do not loosen the knob excessively. Otherwise, the knob might come off and a child might swallow it accidentally.
- To reduce the risk of electric shock, do not touch the SPEAKERS terminals while the power to the unit is on.

NOTICE

If the SPEAKERS terminals come into contact with a metallic rack, a short circuit might occur, resulting in damage to this unit. When installing the unit in a rack, maintain a sufficient clearance to prevent the SPEAKERS terminals from coming into contact with the rack.

Using Y-shaped lug cables

- 1** Unscrew the knob, and then sandwich the Y-shaped lug between the ring part and base of the terminal.

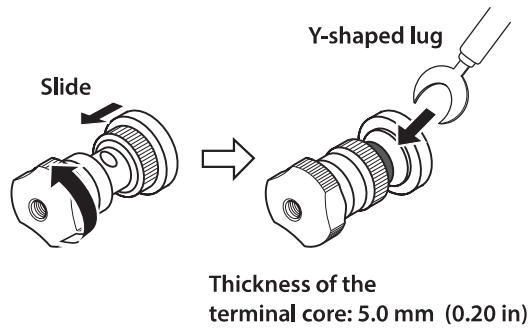

- 2** Tighten the knob.

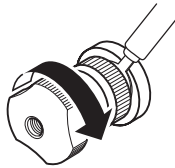

Bi-wiring connections

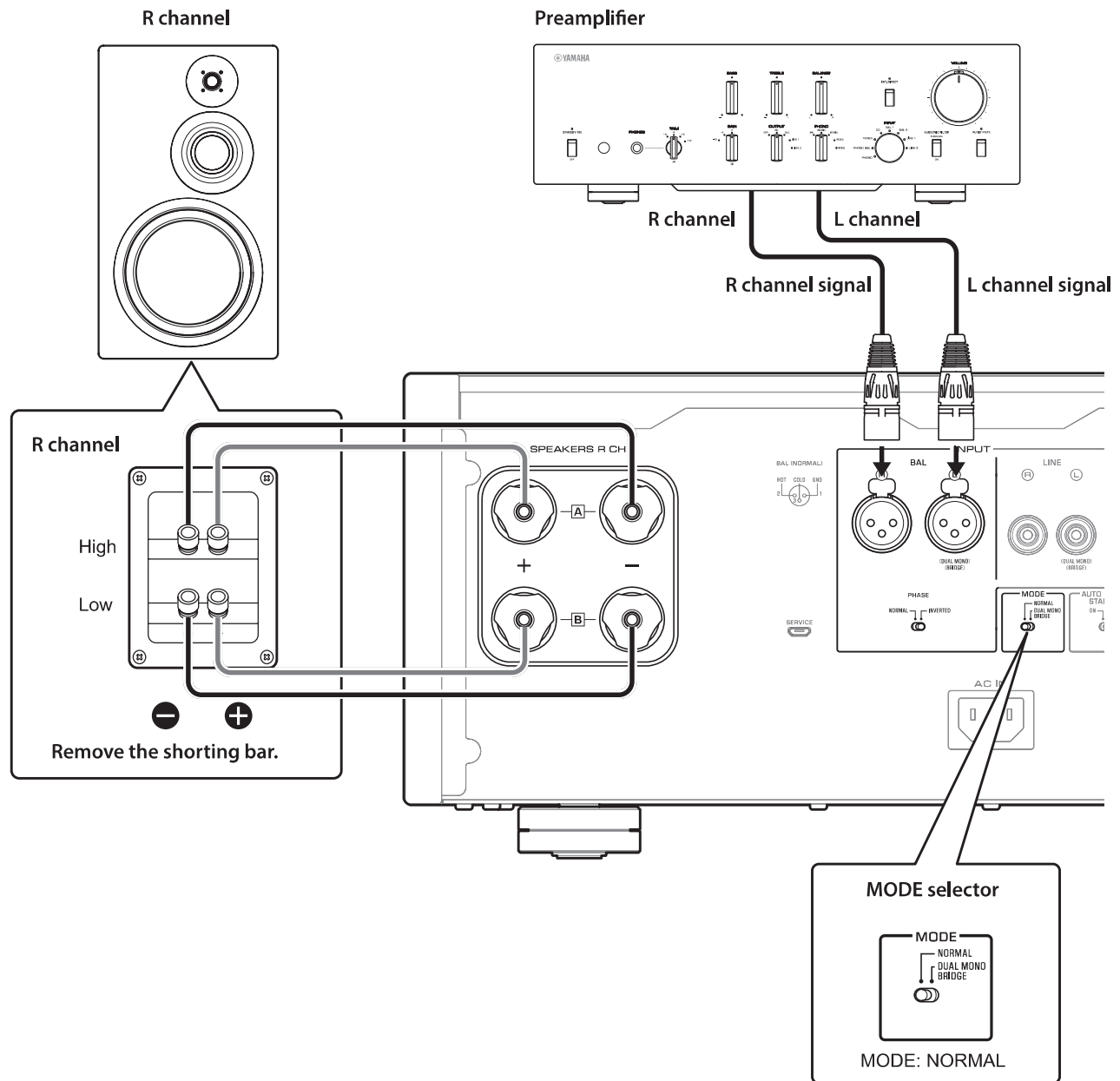

To bi-wire your speakers, separate cables are used to connect the mid/high-frequency speaker driver (tweeter) and the low-frequency driver (woofer) on each bi-wireable speaker to the amplifier. Running separate cables from the amplifier can have a profound impact on relieving the tweeter circuit from the back flush of EMF (electromotive force) generated by the woofer's voice coil, resulting in less interference between HF and LF ranges and better sound quality.

You need to use speakers that feature two sets of terminals (total of four) that allow each speaker to be split into two sections (low-frequency and mid/high-frequency ranges).

1 Turn off the power to the unit and all connected components.

2 Remove the shorting bars or bridges on the speakers.

The LPF (low pass filter) and HPF (high pass filter) crossovers will be separated.

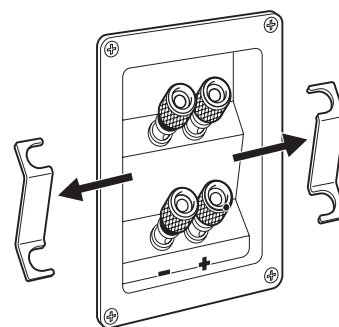

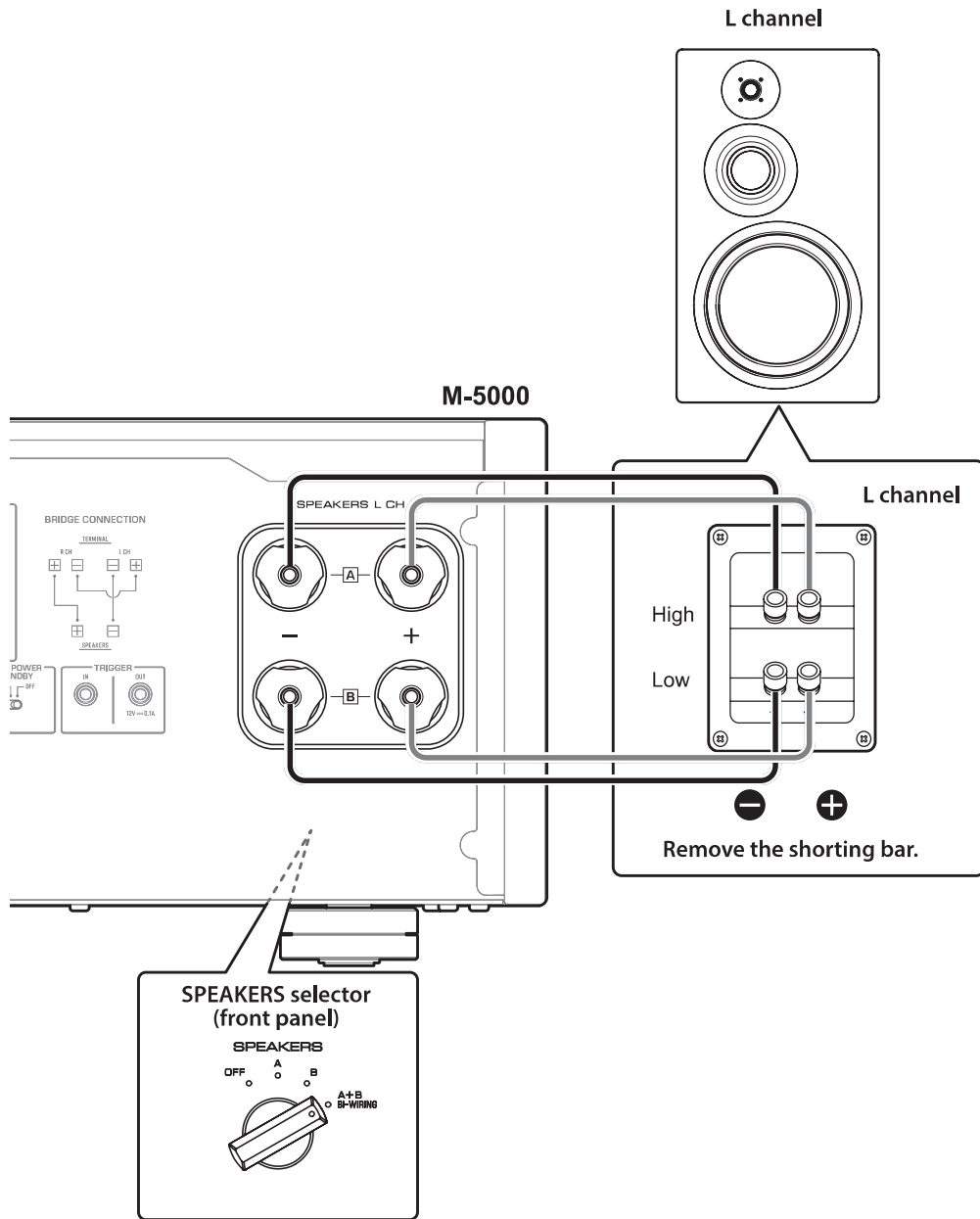

3 Connect the power amplifier to the speakers.

For each channel speaker, connect the cables from the speaker's mid/high range terminals to the amplifier's SPEAKERS A jacks of the corresponding channel, and from the speaker's low range terminals to the amplifier's SPEAKERS B jacks of the corresponding channel respectively.

4 Set the MODE selector on the rear panel to NORMAL.

5 Set the SPEAKERS selector on the front panel to A+B BI-WIRING.

CAUTION

Be sure to use speakers that feature the impedance shown in the table below.

Speaker impedance

SPEAKERS selector	A	B	A+B
Basic connection/ Bi-wiring connection	4Ω or higher		8Ω or higher
Bi-amp connection	4Ω or higher		8Ω or higher
Bridge connection	8Ω or higher		16Ω or higher*

* Excluding models for U.S.A. and Canada

CAUTION

Before turning the power back on to the source component, first lower the volume level on that component.

Bi-amp connections

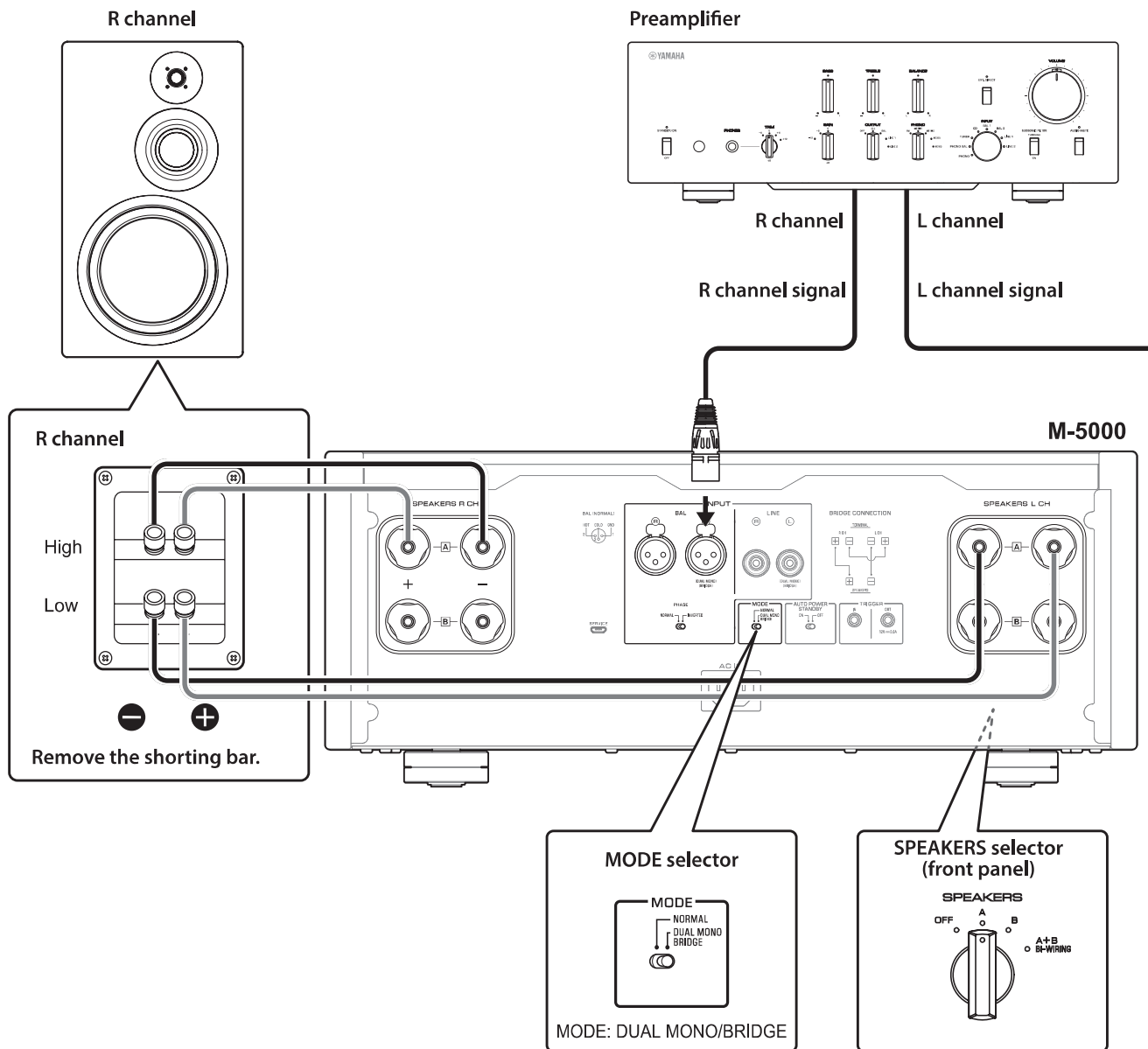

To configure a bi-amp stereo system, you need two M-5000 units.

The M-5000 features two built-in amplifiers. Each of these amps is connected to the mid/high-frequency speaker driver (tweeter) and the low-frequency driver (woofer) on the speaker of the corresponding channel. You need to use speakers that feature two sets of terminals (total of four) that allow each speaker to be split into two sections (low-frequency and mid/high-frequency ranges). Bi-amping speakers can prevent the back flush of EMF (electromotive force) generated by the woofer from affecting the signal, resulting in improved sound quality in some cases.

Connect the input source to the L-channel input jacks on both M-5000 units.

- 1** Turn off the power to the unit and all connected components.
- 2** Remove the shorting bars or bridges on the speakers.

The LPF (low pass filter) and HPF (high pass filter) crossovers will be separated.

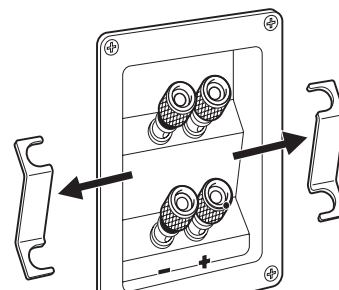

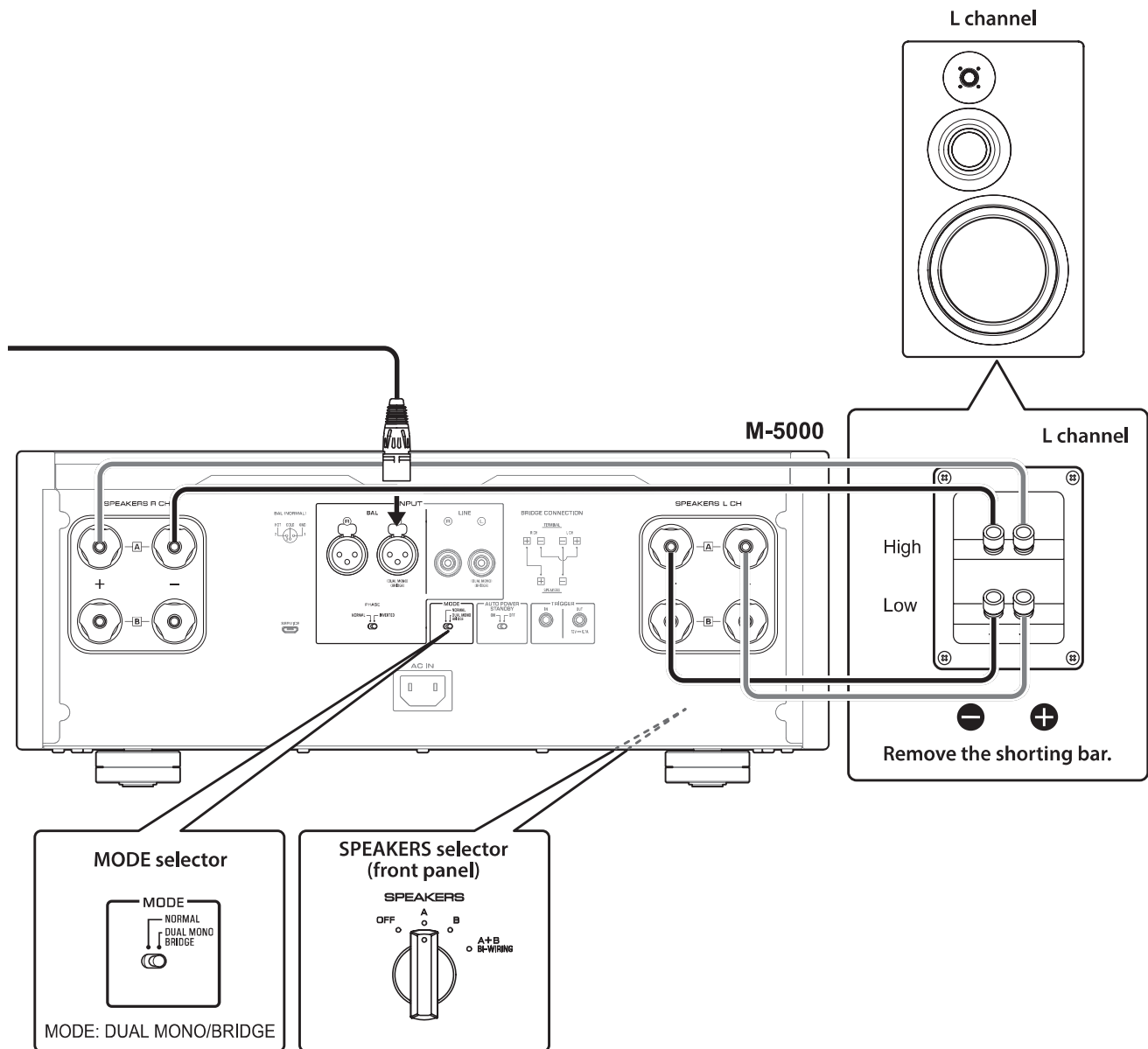

3 Set the MODE selector on the rear panel to DUAL MONO/BRIDGE.

4 Set the SPEAKERS selector on the front panel to A, B, or A+B BI-WIRING.

The diagram shows the selector set to A.

5 Connect the power amplifier (this unit) to the speakers.

For each channel speaker, connect the cables from the speaker's mid/high range terminals to the amplifier A jacks for the SPEAKERS R CH, and from the speaker's low range terminals to the amplifier A jacks for the SPEAKERS L CH.

CAUTION

Be sure to use speakers that feature the impedance shown in the table below.

Speaker impedance

SPEAKERS selector	A	B	A+B
Basic connection/ Bi-wiring connection	4Ω or higher		8Ω or higher
Bi-amp connection	4Ω or higher		8Ω or higher
Bridge connection		8Ω or higher	16Ω or higher*

* Excluding models for U.S.A. and Canada

CAUTION

Before turning the power back on to the source component, first lower the volume level on that component.

Bridge connections

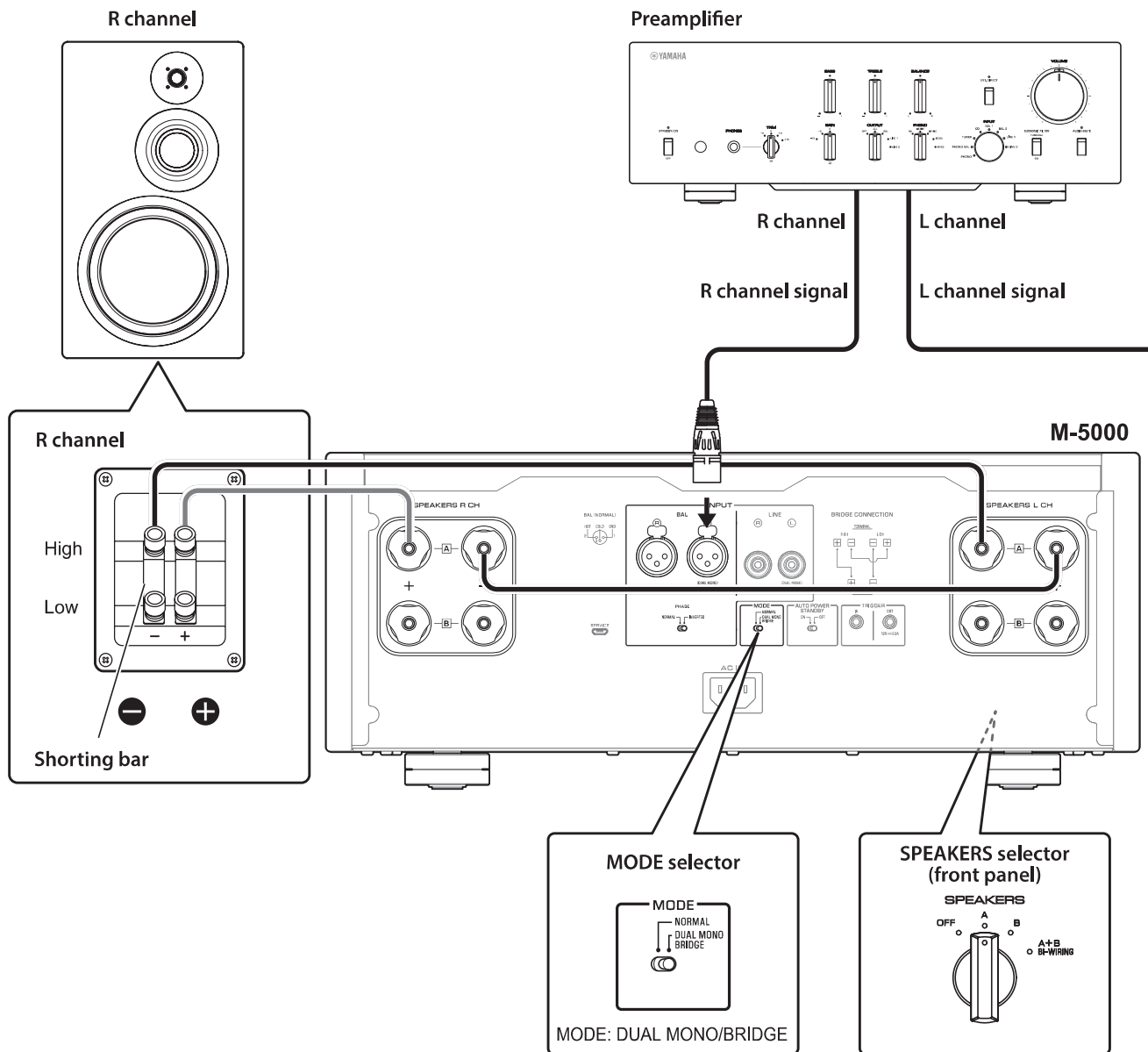

In a bridge connection configuration, the M-5000 is used as a monaural amplifier. To create a stereo system, you need two M-5000 units.

On each amplifier, connect the “+” terminal of the SPEAKERS L CH to the “-” terminal of the SPEAKERS R CH. For this connection, use a cable that features the same material as the speaker cables, and a length of 1.0 m or less and a cross-sectional area of 1.0 mm² or larger. Do not bundle the cable.

Connect the input source to the L-channel input jacks on both M-5000 units.

NOTICE

Since amplification will be doubled in this configuration, adjust the volume level appropriately on the connected preamplifier. If you are using a Yamaha preamplifier that features a GAIN selector, adjust the volume level using this selector so that you will be able to use volume controls on other components in the usual way.

- 1** Turn off the power to the unit and all connected components.
- 2** Set the MODE selector on the rear panel to DUAL MONO/BIDGE.

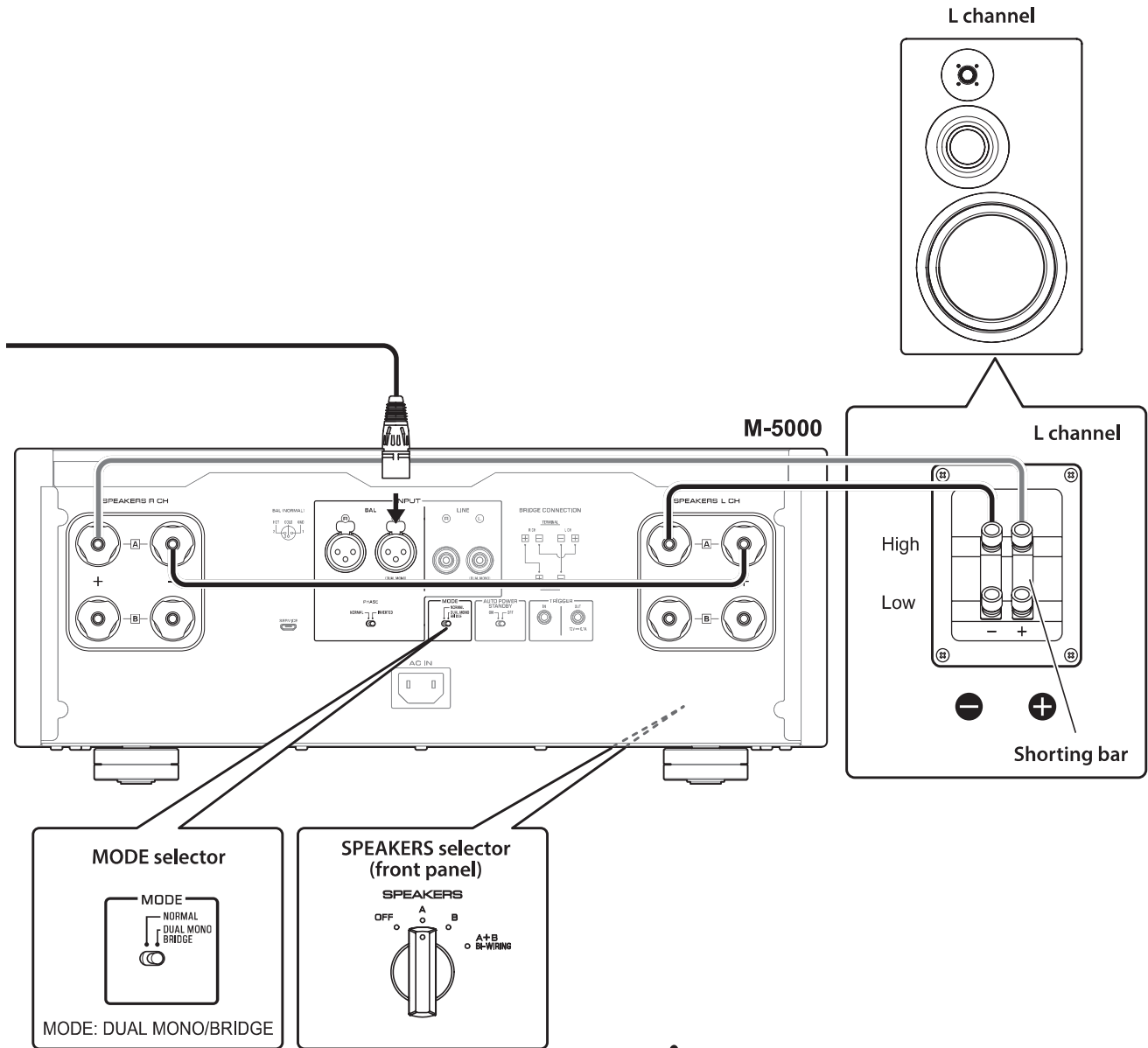

- 3** Set the **SPEAKERS selector** on the front panel to **A**, **B**, or **A+B BI-WIRING**.

The diagram shows the selector set to **A**.
- 4** On each amplifier, connect the **“+”** terminal of the **SPEAKERS L CH** to the **“-”** terminal of the **SPEAKERS R CH**.
- 5** Connect the **“+”** terminal of the **SPEAKERS R CH** to the speaker’s **“+”** terminal, and the **“-”** terminal of the **SPEAKERS L CH** to the speaker’s **“-”** terminal.

CAUTION

Be sure to use speakers that feature the impedance shown in the table below.

Speaker impedance

SPEAKERS selector	A	B	A+B
Basic connection/ Bi-wiring connection	4Ω or higher		8Ω or higher
Bi-amp connection	4Ω or higher		8Ω or higher
Bridge connection	8Ω or higher		16Ω or higher*

* Excluding models for U.S.A. and Canada

CAUTION

Before turning the power back on to the source component, first lower the volume level on that component.

Connecting the power cord

After all connections are complete, make sure that the STANDBY/ON/OFF (Power) switch is turned off, then plug the power cord into the AC IN connector of the unit, and then plug the power cord into the AC outlet.

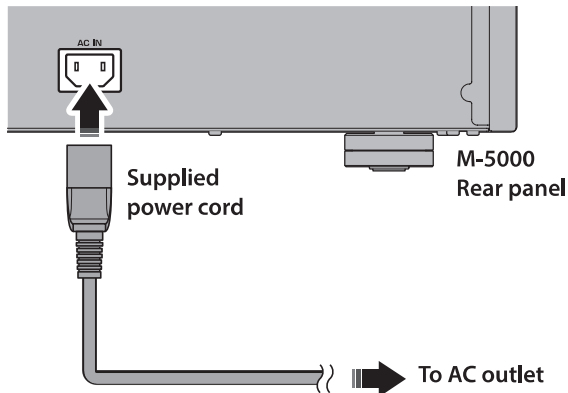

CAUTION

- Do not use an AC outlet that is so loose that the plug does not stay firmly in place. Otherwise, fire, electric shock, or burning might be caused.
- When disconnecting the power cord from the AC outlet, grasp the plug; do not pull the cord. Otherwise, the power cord may be damaged, causing an electric shock or fire.
- Insert the power plug into the AC outlet all the way firmly. If the plug is not inserted completely, use of the unit might cause an electric shock. Or, dust might build up on the plug, causing fire or burning.

NOTICE

If you plan not to use the unit for an extended period of time, be sure to unplug the power cord from the AC outlet. Even when the STANDBY/ON/OFF (Power) switch is turned off (the power indicator is dark), a minimal amount of electric current is still flowing to the unit.



WARNING

- If you notice any of the following abnormal conditions, turn off the power to the unit immediately, and disconnect the power plug from the AC outlet.
 - The power cord or plug is damaged.
 - The unit is emitting odor, strange noise, or smoke.
 - Liquid has been spilled or objects have fallen into the unit.
 - Sound is muted all of a sudden during the operation.
 - The unit is cracked or damaged.

Otherwise, continued use of the unit might lead to electric shock, fire, or malfunction. Contact your nearest Yamaha dealer or service center for check-up or repair.

- Do not touch the power cord or plug during lightning storms. Otherwise, an electric shock might be caused.
- Be sure to use a power outlet with the power voltage labeled on the unit. If the unit is plugged into an outlet of an inappropriate voltage, fire, electric shock, or malfunction might be caused.
- Use only the supplied power cord. Do not use the supplied power cord for other devices. Otherwise, fire, burning, or malfunction might be caused.
- Plug the unit into an AC outlet that is clearly visible and easily reached, so that you can unplug the unit easily and quickly from the AC outlet in case of emergency. Even when the power switch is turned off, a minimal amount of electric current is still flowing to the unit, unless you unplug the unit from the AC outlet.
- If a lightning storm is approaching, turn off the power to the unit immediately, and disconnect the power plug from the AC outlet. Otherwise, fire or malfunction might be caused.
- If you plan not to use the unit for an extended period of time, be sure to unplug the power cord from the AC outlet. Otherwise, fire or malfunction might be caused.