



DEVA Pro

Owner's Guide



DEVA

Deva (देव) is Sanskrit meaning "Heavenly"

TABLE OF CONTENTS

2	Message from the Founder
3	Headphone Overview
	Outstanding Sound Quality
	The Stealth Magnets
	HIFIMAN NEO "Super Nano Diaphragm"
	Cable Connections
11	Packing List
11	Specifications
12	Headband Adjustment
12	Replacing Ear Pads
15	Safety Instructions
16	Use and Maintenance Precautions
17	Bluemini/USB Dongle
18	Operation Guide
19	Precautions for Use
20	Himalaya DAC Embedded
21	Multiple HD Audio Protocols
21	Specifications
23	HIFIMAN Limited Warranty



Message from the Founder

Thank you for your purchase of a HIFIMAN product. We take great pride in offering audio products that provide best-in-class performance and value.

Though it seems like only yesterday when, as a passionate audiophile, I started HIFIMAN, we just finished our first decade in business and eagerly look forward to an exciting future. The company continues to grow at a rapid pace, and the HIFIMAN brand is one of the most respected in the industry.

Even with our success, two things that never change are my love of music and my commitment to creating products that recreate the experience of hearing a live performance. I am joined by many others in the company who share my passion and in turn, we humbly share our passion with you.

Thank you again for your purchase. I hope you will find this guide a useful tool for learning about your product, ultimately helping you enjoy countless hours of pleasure.

Happy listening,

Fang

Dr. Fang Bian,
Founder and CEO

Outstanding Sound Quality

Compared to traditional dynamic headphones, planar magnetic technology offers a superior sounding experience in terms of overall quality, especially when it comes to the aural soundstage. Dynamic headphones utilize conductors that vibrate in select areas of the diaphragm. This results in a large percentage of the diaphragm not being directly driven by those conductors, resulting in somewhat diminished performance. Planar magnetic headphones are fundamentally different in that their weight (conductors + diaphragm) is much lower than dynamic headphones. The result is superior performance, especially in the upper frequencies, or treble.

$$f_{hi} = \frac{1}{2\pi} \sqrt{\left(\frac{1}{m_1} + \frac{1}{m_2}\right)} \cdot s_n$$

f_{hi} : upper frequency bound
 m_1 : mass of diaphragm
 m_2 : mass of conductor traces

A smaller mass from either the diaphragm or conductor results in improved upper frequency response.

Planar headphones feature conductive layers distributed throughout the surface of diaphragm. The diaphragm is evenly driven by the magnetic force so that planar headphones produce significantly lower distortion when compared with conventional dynamic headphones.

This lower distortion results in better overall reproduction of minute details. Positioning of instruments and other elements of imaging are demonstrably better, with a soundstage that is consistently wide and natural sounding.

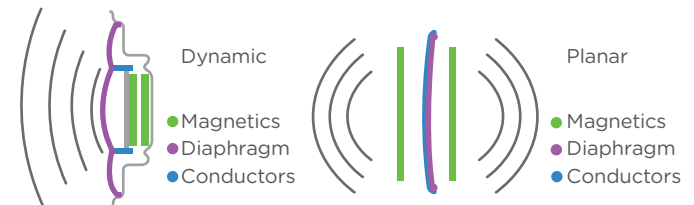

The Stealth Magnets



The advanced magnet design featured in the DEVA Pro is acoustically transparent, dramatically reducing wave diffraction turbulence that typically degrades the integrity of the sound waves. The result is reduced distortion, yielding a purer, more harmonious sound that is demonstrably better than previous designs.



HIFIMAN NEO

“Super Nano Diaphragm”



HIFIMAN devoted extensive time and resources to create a nano scale thickness diaphragm that allows for lightning fast response that not only produces stunning levels of detail but ultra-low distortion too. Making use of technologies originally developed for such revered models as the HIFIMAN Susvara, and borrowing the same driver shape, the DEVA Pro offers performance levels and musical purity that exceed expectations, especially for such an affordable headphone.

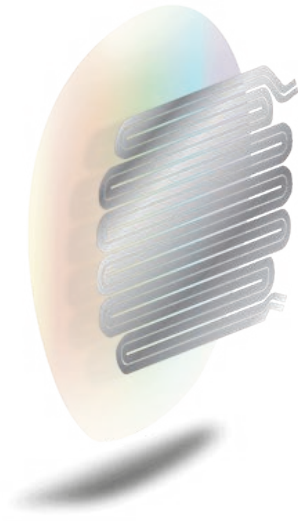

Cable Connections

The DEVA Pro is packaged with an audiophile-grade custom-designed dual-sided 3.5mm cable. Its high sensitivity allows it to maximize the sonic output of almost any source, including tablets, smartphones, laptop PCs, and digital audio players

The Bluemini R2R wireless audio dongle is not a default accessory for the wired version of the DEVA Pro. It is sold separately, in addition to being packaged with the wireless version of the DEVA Pro.

It is important to confirm compatibility before using an aftermarket cable. For details, please refer to the structure design of the stock cable as below.

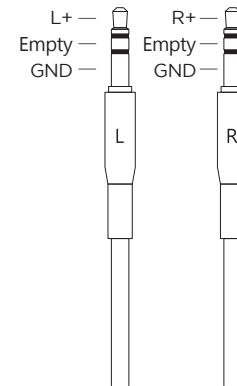

**Dual-sided 3.5mm cable
(3.5mm TRS connection)**

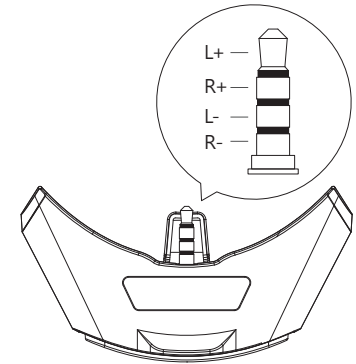

**Bluemini Dongle
(3.5mm TRRS connection
on the left socket)**

DEVA Pro is not compatible with TS cable

HIFIMAN DEVA Pro

Advanced Active Headphone



Packing List

- (1) Dual-side 3.5mm plug headphone cable (1.5m)
- (1) 6.35mm Adaptor

Headphone Specifications

Frequency Response: 20Hz-20kHz

Impedance: 18Ω

Sensitivity: 93.5dB

Weight: 360g

Headband Adjustment

To help fit the headphone to your head, use the two adjustment blocks to change the position of the headband strap until the perfect fit is achieved.



Replacing Ear Pads

To remove the ear pads, locate the clips on the inside of the pad, and use two fingers to bend them in and slip them out gently. To install new pads, align the ear pad with the mounting ring and gently bend the clips to slot in their appropriate locations.

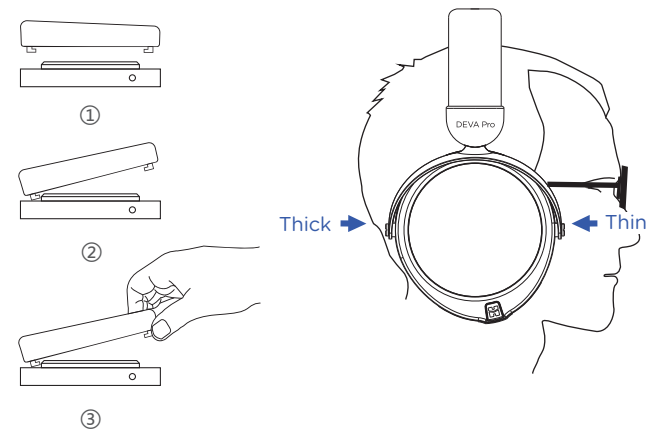

HIFIMAN DEVA Pro



Safety Instructions

Body Safety Instructions

- Please listen to the DEVA Pro at moderate listening levels so that you can continue to enjoy their audio quality for years to come. You only have one pair of eardrums, so please look after them.
- Do not use any headphone while driving or operating machinery.
- For a long product life, the DEVA Pro should be kept away from pets and small children.
- Wipe the surfaces (ear pads, cups, etc.) with a microfiber cloth and store the headphone in a dry, cool and safe place that is away from dust, heat, humidity, sunlight, young children and pets. Periodically wipe the headband to remove any dust.
- Planar headphones benefit from break-in to achieve optimum performance. This can take up to 150 hours. However, the sound is great out of the box, so continue to enjoy your headphones throughout the break-in period.
- Modification without authorization, such as changing the transmission frequency, increasing the transmission power, or other alterations will invalidate the warranty.
- Use only accessories that are officially provided or recommended by HIFIMAN.

Product Safety Instructions

- If the headset emits abnormal noise, abnormal heat or abnormal sound, please remove the headset immediately and contact HIFIMAN Customer Services.
- The DEVA Pro is not waterproof. Do not expose it to moisture or water, e.g. do not wear it in the rain.
- Do not use the product near a heat source or expose it to heat for a long time. The headset contains a battery, so avoid extreme temperatures.
- Do not use volatile substances including alcohol, acetone, gasoline or dish detergent to clean the headphone.

Maintenance Precautions

- If the headset will remain idle for an extended period, HIFIMAN strongly recommends that you place a moisture-proof agent in the box (purchase separately) to avoid mold.
- In order to prevent dust from entering the headphone, do not disassemble the ear pads more than necessary. To clean the headphones, wipe them with a slightly damp soft cloth. Do not use any cleaner and ensure that no liquid will flow into the headphones.
- The leather should be maintained with leather-specific products. The internal headphone unit does not require maintenance.
- If the unit is disassembled without authorization, it may void the warranty.

Bluemini/USB Dongle

Small, powerful and versatile with maximum functionality. Bluemini turns the compatible headphone into a wireless Bluetooth headphone offering superb dynamics and crystal-clear audio. You can also use Bluemini as an integrated amp and DAC by connecting to a phone or computer via a USB-C cable. Bluemini will act as the perfect companion integrated amplifier and DAC for true audiophile grade sonics. Superb dynamics, clarity and an analog tube-like smoothness to satisfy the most demanding music fans.



Operation Guide

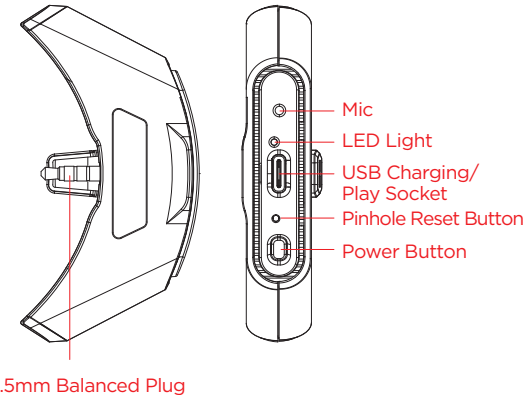

In playback mode, tap the power button once to start / pause playback. To answer / finish a call, press the power button once. To reject, please press and hold the power button 2 seconds.

- * When using a computer as the audio input device, there is no need to install drivers when the OS is WIN10 or MacOS. For WIN 8 and older OS, not all devices can be connected by USB mode.
- * To connect with Android phones, you will need a compatible cable. If connected to a portable device including mobile phones, the lack of a power supply may result in faster than usual battery drainage. Not all Android phones can support OTG audio. iPhones are currently not compatible due to power limitation.
- When first connecting to a source via Bluetooth, press the power button for one-to-two seconds. Once the blue light flashes twice to indicate that the power is on, press the power button twice to enter the pairing mode. The light will alternately flash blue and green. At this point, check for it in the device's Bluetooth connection list. Click Connect to complete the pairing

- To connect a paired Bluetooth audio output device, simply press the power button for one-to-two seconds. The blue light will continue to flash at intervals. If the previously paired Bluetooth device is turned on, it will automatically attempt to connect.
- Press power button for five seconds to turn it off.
- To charge, connect the USB charging cable to both the power supply and the Bluemini. Charging will occur whether or not the Bluemini is on. The light will remain red. When turned on the light will flash red and blue while charging and once fully charged the light will flash green and blue.
- To enable the USB playback mode, connect the audio device with a USB cable to enter USB play mode. The light will flash red and blue in this mode.
- In the event of a software issue, press and hold the Pinhole Reset Button for six seconds to restore factory settings.

N.B.: USB playback mode can be used only if the audio playback device and USB cable support audio playback. The choice of USB cable may affect playback quality.

Precautions for Use

- Bluemini R2R does not work with official IOS phones or tablets. If you need further assistance, please contact HIFIMAN Customer Service.
- Microphone feature is not available in USB DAC mode.
- Due to the limitation of Bluetooth wireless technology, the audio of the media playback device may experience a slight delay. Sound and images may not be synchronized when watching a video or playing a game.
- Use the Bluemini only in locations that allow Bluetooth wireless transmission.
- Bluetooth wireless technology typically works within 10 meters. Reception is affected by such factors as obstacles, electromagnetic environments, and other factors..

- The Bluemini is Bluetooth-compliant and the device connected to the Bluemini must also comply with the Bluetooth standard. HIFIMAN does not guarantee that all Bluetooth devices will be connected to the Bluemini.
 - The time for connecting the Bluemini to different devices may vary.
 - The Bluemini can only be charged using the supplied USB cable.
 - The battery may be exhausted if the Bluemini is not used for a long time. If the battery is running out too fast, it may need to be replaced. Please contact your nearest HIFIMAN dealer.
 - For maximum performance, the battery should be charged a minimum of once every 90 days.
- * The Bluemini includes electronic components and a battery. When recycling, please contact your local sanitation department for disposal and recycling requirements.

Hymalaya DAC Embedded

Bluemini R2R is enabled by ultra-small Hymalaya R2R DAC, HIFIMAN custom created module, which features low-energy consumption and high sampling rates.

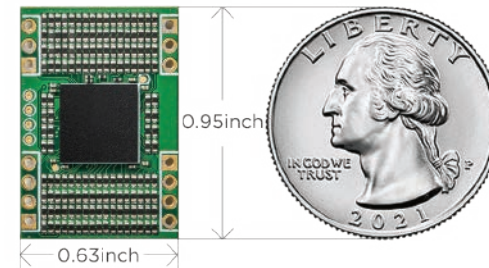

Multiple HD Audio Protocols

The Bluemini supports the current mainstream HD music transmission protocols, including LDAC™, aptX™, aptX-HD™ and more, ensuring it is fully compatible with the majority of HD playback devices on the market.



Qualcomm®
aptX™ HD



Qualcomm®
aptX™



- * LDAC™ and the LDAC™ logo are registered trademarks of Sony Corporation.
- * aptX™ and aptX-HD™ and their logo are registered trademarks of Qualcomm Incorporated.
- * Bluetooth and its logo are registered trademarks of Bluetooth SIG.

Specifications

Bluetooth Version: Bluetooth 5.0
 Frequency Response: 20Hz-20kHz
 Battery Life: 6-7 Hours
 Weight: 25g
 With Built-in Microphone



FCC STATEMENT

1. This device complies with Part 15 of the FCC Rules. Operation is subject to the following two conditions:
 - (1) This device may not cause harmful interference, and
 - (2) This device must accept any interference received, including interference that may cause undesired operation.
2. Changes or modifications not expressly approved by the party responsible for compliance could void the user's authority to operate the equipment.

FCC Radiation Exposure Statement:

The device has been evaluated to meet general RF exposure requirement. The device can be used in portable exposure condition without RF striction.

NOTE: This equipment has been tested and found to comply with the limits for a Class B digital, pursuant to Part 15 or the FCC Rules. These limits are designed to provide reasonable protection against harmful interference in a residential installation. This equipment generates, uses and can radiate radio frequency energy and, if not installed and used in accordance with the instructions, may casue harmful interference to radio communications, However, there is no guarantee that interference will not occur in a particular installation. If the equipment does cause harmful interference to radio or television reception, which can be determined by turning the equipment off and on, the user is encouraged to try to correct the interference by one or more of the following measures:

- Reorient or relocate the receiving antenna.
- Increase the separation between the equipment and receiver.
- Connect the equipment into an outlet on a circuit different from that to which the receiver is connected.
- Consult the dealer or an experienced radio / TV technician for help.

HIFIMAN Limited Warranty

Your product is warranted for a period of one year beginning with the original date of purchase. If you join HIFIMAN on Facebook, your product warranty will be extended for an additional six months. Please contact HIFIMAN customer service if you need any assistance.

The dated sales or delivery receipt is your proof of purchase. You may be required to provide proof of purchase as a condition of receiving warranty service so please keep it handy.

If your product is under warranty and malfunctions occur, please contact HIFIMAN customer service or your authorized dealer. If necessary, and at the discretion of HIFIMAN, the company will provide a warranty repair or replacement of your product.

Caution: do not disassemble or modify the product in any way. Tampering with or modifying your HIFIMAN product will void its warranty.

This Limited Warranty does not apply to :

1. Defective or discolored parts if the damages are caused by fluids, dirt, missing keys, broken plastic parts or improper use.
2. Damage caused by misuse with another product.
3. Use of the product for other than its normal intended use, including, without limitation, failure to use the product in accordance with the supplied "Owner's Guide"

4. Damage caused by accident, abuse, neglect or misuse.
5. If you do not have a valid dated receipt showing proof of purchase.
6. Damage caused by services/repairs or other modifications to the system carried out by anyone other than HIFIMAN or an authorized HIFIMAN distributor or dealer.
7. Damage caused by self-repair or if the unit has been disassembled or modified in any way.

HIFIMAN guarantees your satisfaction and will do everything reasonable to achieve that. If you have any questions or concerns with your product, simply contact your authorized dealer or HIFIMAN directly (if purchased from us) and explain the issue in detail. Should a return be required, a RA# will be issued. Return shipping to HIFIMAN or authorized service facility will be at the owner's expense.

The warranty applies to the first purchaser and is not transferable. Should you need warranty service please contact your authorized HIFIMAN dealer. Or email us directly at customerservice@HIFIMAN.com

If you have any concerns with your product: please contact us to explain the issue in detail. If a return/refund is required, a RA# will be issued. Return shipping to HIFIMAN or authorized service facility is done at the owner's expense.

For any further information or questions, please contact your authorized HIFIMAN dealer. Or email us directly at customerservice@HIFIMAN.com.



facebook.com/hifimanelectronics



twitter.com/hifimanofficial



www.hifiman.com

